

Product catalogue

THE FINEST IN KEYLESS SECURITY



Simons  Voss

Simons  Voss
technologies

- 04 SYSTEM 3060
06 G2-BASED SYSTEMS

ACTIVE TECHNOLOGY

- 11 IDENTIFICATION MEDIA AND THEIR PROGRAMMING
– Identification media
– Programming
- 21 DIGITAL LOCKING CYLINDER
– Digital Locking Cylinder 3061
– Thumb-turns & accessories
– Configuration
- 55 DIGITAL SMART HANDLES
– Digital Smart Handle 3062
– Digital Smart Handle 3062 – Scandinavian Oval
- 65 DIGITAL SMART RELAYS
– Digital Smart Relay 3063
– Digital Smart Output Module
– Digital Smart Relay 2 3063
- 71 VdS BLOCK LOCK
- 75 OTHER PRODUCTS

PASSIVE SMART CARD TECHNOLOGY

- 81 IDENTIFICATION MEDIA AND THEIR PROGRAMMING
– Identification media
– Programming
- 91 DIGITAL LOCKING CYLINDER
– Digital Locking Cylinder 3061 – SC
– Configuration
– Digital Locking Cylinder 3061 – Hybrid
– Configuration
– Thumb-turns & accessories
- 123 DIGITAL SMART HANDLES
– Digital Smart Handle 3062 – SC
– Digital Smart Handle 3062 – Scandinavian Oval – SC
– Digital Smart Handle 3062 – Hybrid
– Digital Smart Handle 3062 – Scandinavian Oval – Hybrid
- 143 DIGITAL SMART RELAY 2
- 146 OTHER PRODUCTS

MULTI-NETWORKING

- 148 – WaveNet Radio Network 3065
– WaveNet Radio Network 3065 – Protective function
– WaveNet Radio Network 3065 – Direct networking
– Accessories and licences

LSM SOFTWARE

- 158 – LSM Software

SUPPORT

- 172 – Services and training
– Sales support
– Product overview

CONTACT



THE KEYLESS SIMONS VOSS WORLD:
TECHNOLOGIES WHICH YOU BENEFIT FROM.

Access control in new dimensions.

We at SimonsVoss aim to make your life and working environment safer, more convenient and more cost-effective. To achieve this aim, we have revolutionised conventional mechanical lock systems using digital technology and integrated access control functions

SimonsVoss sets benchmarks on an international level.

Our idea of using a digital transponder instead of a conventional key has spread worldwide. We have consistently and successfully implemented this vision based on our radio-controlled, cable-free lock and access control system. SimonsVoss is thus an undisputed technology leader in the rapidly growing market for battery-operated digital lock and access control systems. More than 10,500 installed systems, 1,000,000 digital locking cylinders/Smart Relays and 3,000,000 transponders across the world provide conclusive proof that our vision has already become a reality.

Strong presence in numerous countries.

SimonsVoss is now represented through subsidiaries or partners in the UK, Austria, France, Italy, Spain, the Benelux, Denmark, Sweden, Singapore, the Middle East, the US, China and Russia. The parent company in Unterföhring, near Munich, is the main centre for administration, central departments and development while production and logistics are based in Osterfeld/Sachsen-Anhalt in central Germany.

DISCOVER THE KEYLESS WORLD
OF SIMONS VOSS.

The SimonsVoss Digital Locking System 3060 is an electronic version of a mechanical locking system with the functions of a typical access control system. Mechanical keys are replaced by active transponders, passive smart cards, Mobile Keys, PIN code keypads or biometric wall readers. Digital locking cylinders and digital fittings are used instead of mechanical locking cylinders while radio communication replaces the mechanical authentication of a key. Data is transmitted from a transponder or smart card to the locking cylinder or Smart Relay at a frequency of 25 kHz or 13.56 MHz.

Intelligent relays (Smart Relays) enable electronic switches to be activated using an authorised transponder.

The following options are available to programme System 3060, depending on the system size and personal preferences:

- ⚙ With a programming transponder without any software whatsoever
- ⚙ With a smart phone via the NFC cloud
- ⚙ With a USB config device or a programming device and software
- ⚙ Via the cable-free WaveNet network

All components can be networked at any time, even at a subsequent stage. Multi-networking offers a suitable solution for all system sizes. This is provided by network-ready Network Inside components, the WaveNet radio network (frequency of 868 MHz) and the retrofit network thumb-turn cover for existing components.

TRANSPONDERS

SMART CARD

MOBILE KEY

MULTI-NETWORKING

SOFTWARE

DIGITAL LOCKING CYLINDER



SMART HANDLE



SMART RELAYS



MULTI-NETWORKING

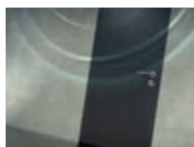

SOFTWARE



G2 LOCK SYSTEMS.

The term 'G2' was introduced to distinguish new systems from G1 systems. Highly developed communications protocols enable the G2 firmware generation to form even larger, more powerful lock systems and also network them virtually.

Special characteristics of G2-based systems:

- ⚡ Programming can be performed using the media (transponders, smart cards, smart tags and similar) or the locking devices, depending on which method involves less work for system management.
- ⚡ If authorisations differ between the medium and the locking device, the data programmed last are considered valid.
- ⚡ If active transponders are used, these will ensure that the time is checked in the locking devices and corrected if necessary.
- ⚡ G2 systems can be networked virtually.
- ⚡ Changes to authorisations are only updated in the media in virtually networked systems.
- ⚡ Up-to-date information is exchanged between the media and the locking devices when online doors are opened or closed in virtually networked systems. This ensures that lost or stolen transponders can be deactivated in locking devices.

G1

This symbol appears on products which can be used in G1 systems.

G2

This symbol appears on products which can be used in G2 systems.

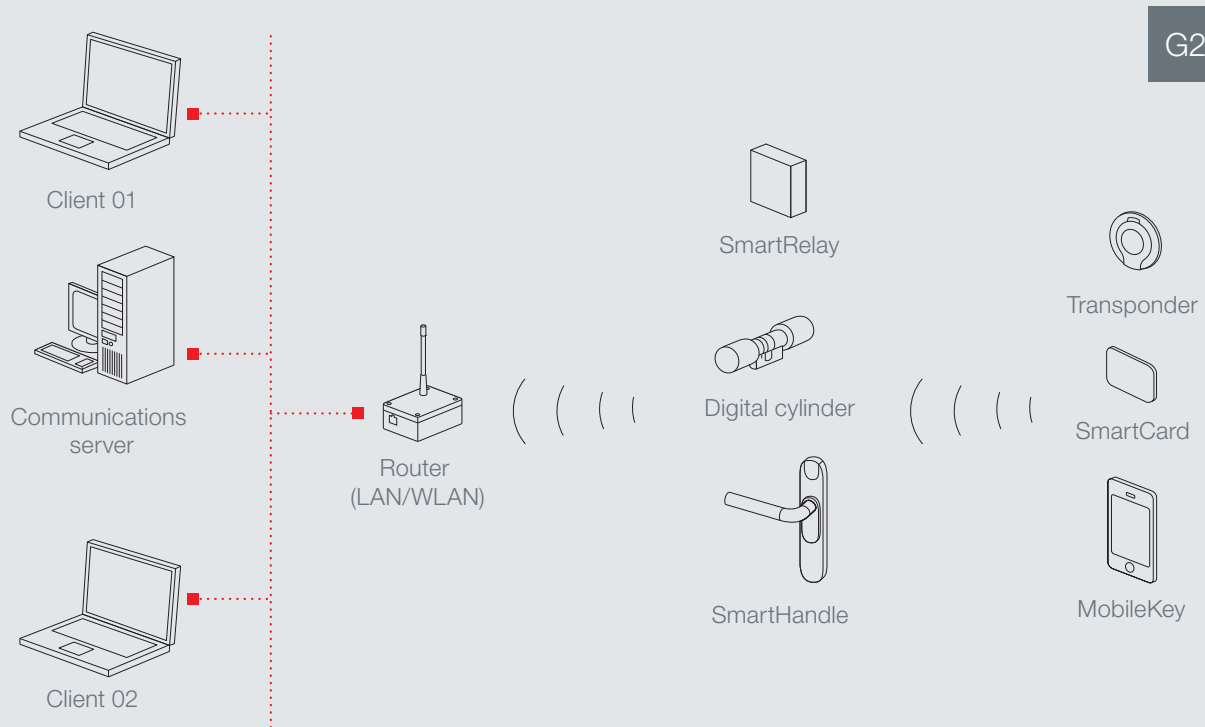

PERFORMANCE CHARACTERISTICS OF G2-BASED SYSTEMS:

- ⚡ Up to 64,000 locking devices per system
- ⚡ Up to 64,000 transponders/smart cards per locking device
- ⚡ Up to 1,000 accesses can be stored on the transponder per lock system
- ⚡ Up to 100 time zones can be managed
- ⚡ Up to 304,000 locking devices per transponder
- ⚡ Up to 32,000 locking devices per smart card
- ⚡ Up to 3,000 access events can be stored on a locking device / 3,600 on an SREL

PERFORMANCE CHARACTERISTICS OF G2-BASED SYSTEMS IN VIRTUAL NETWORK MODE:

- ⚡ Changes to lock authorisations can be made on transponders. This occurs unnoticed by the user when they pass by Gateway locking devices (networked Smart Relays/locking cylinders).
- ⚡ To ensure that locking authorisations are fully up to date, users receive a time-limited access authorisation on their transponder from a networked Gateway locking device, usually for twelve hours. Once this period comes to an end, the user needs to re-authorise their transponder at a networked Gateway locking device. Time-limited authorisations can either be based on a specific time or use an allocated number of hours as an alternative.
- ⚡ Transponder users may also carry the blocking command for other transponder users to the locking device, for example. This blocking command is transmitted to the locking device concerned unnoticed by the user.

All components must be G2-compatible if they are to be used with G2 products in a SimonsVoss lock system. This means:

- ⚡ G2-compatible lock plan software (LSM Version 3.0 or higher)
- ⚡ G2-compatible programming device (SMARTCD.G2, SMARTCD.MP)
- ⚡ G2-compatible transponder (TRA.G2)
- ⚡ G2-compatible locking devices (Z4.xx-xx.G2, SH...G2 or SREL.G2 and SREL2.G2)

ACTIVE TECHNOLOGY



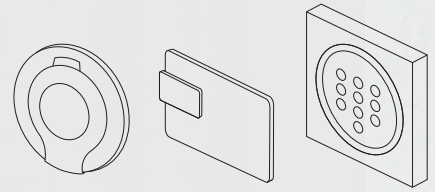

ACTIVE TECHNOLOGY
IDENTIFICATION MEDIA
AND THEIR PROGRAMMING



TRANSPONDER 3064

G1

G2

Blue, red or brown, with bonded housing or consecutive numbering. There are virtually no limits to the variety of possible types of transponders: as a password or fire service transponder, an explosion-proof design or one with additional chip. Manage an incredible 304,000 locking devices with your transponder and open doors and gates up to a million times with a single battery.

A transponder is used for identification to operate digital locking cylinders, Smart Handles and Smart Relays in System 3060.

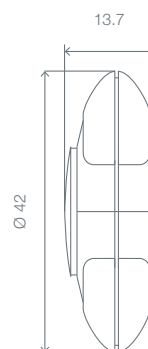

Measurements indicated in mm

TECHNICAL SPECIFICATIONS

- ⌘ Housing made of black polyamide
- ⌘ Dimensions: 42 x 13.7 mm (Ø x H)
- ⌘ Protection rating: IP 65; with bonded housing: IP66
- ⌘ Typical read range: up to 40 cm to the locking cylinder/ Smart Handle; up to 120 cm to Smart Relay
- ⌘ Battery type: 1 x CR2032, 3 V, lithium
- ⌘ Battery life:
 - G1: up to 1 million lock operations or up to ten years on standby
 - G2: up to 400,000 million lock operations or up to ten years on standby
- ⌘ Temperature range: -25 °C to +65 °C
- ⌘ Environmental class: III
- ⌘ Number of locking devices which can be managed per transponder.
 - G1: up to 48,000
 - G2: up to 304,000
- ⌘ Adjustable validity period (activation/deactivation):
 - G1: up to 6 months in advance
 - G2: more than 10 years
- ⌘ Storage of datasets:
 - G1: 3 separate lock systems
 - G2: 3 G1 and 4 G2 lock systems
- ⌘ Physical access list with up to 1,000 storable access events (G2 version only)

TRANSPONDER 3064

Transponder 3064 with dark red button

Transponder 3064 with brown button



PRODUCT VERSIONS

| | |
|--|-----------------|
| Transponder 3064 ID medium in Digital Lock System 3060, in robust housing with blue buttons; diameter: 42 mm, protection rating: IP65 (for G1 only) | TRA |
| Transponder 3064 with G1 and G2 functions (discontinued) | TRA.G2 |
| Transponder 3064 with G1 and G2 functions | TRA2.G2 |
| Version with dark red button | .ROT |
| Version with brown button (available as G2 version only) | .BRAUN |
| Version with consecutive numbering throughout the whole ordered quantity (for G1 only) | .NR |
| Version with consecutive numbering as per customer requirements. Up to six alpha-numerical characters possible; minimum order of 100 devices | .NR.K |
| Version with bonded housing: | .SPEZ |
| Version with additional EM [®] 4102 chip (programmed by customer to operate third-party systems) | .RFID.EM |
| Version with additional EM [®] 4450 chip (programmed by customer to operate third-party systems) | .RFID.EM4450 |
| Version with additional HITAG [®] 1 chip (programmed by customer to operate third-party systems) | .RFID.HITAG |
| Version with additional HITAG [®] 2 chip (programmed by customer to operate third-party systems) | .RFID.HITAG2 |
| Version with additional ATMEL [®] ATA5567 chip (programmed by customer to operate third-party systems) | .RFID.AT5567 |
| Version with additional HID [®] 1390 eProx chip (programmed by customer to operate third-party systems) | .RFID.HID |
| Version with additional HID [®] iClass (2k/2) chip (programmed by customer to operate third-party systems) | .RFID.ICLASS |
| Version with additional MIFARE [®] Classic (1k) chip (programmed by customer to operate third-party systems) | .RFID.MIFARE |
| Version with additional MIFARE [®] DESFire [®] (2k) chip (programmed by customer to operate third-party systems) | .RFID.DESFIRE |
| Version with additional MIFARE [®] DESFire [®] (8k) chip (programmed by customer to operate third-party systems) | .RFID.DESFIRE8K |

TRANSPONDER 3064

| | |
|--|------------------|
| Version with additional LEGIC® PRIME (MIM256) chip (programmed by customer to operate third-party systems) | .RFID.LEGIC |
| Version with additional LEGIC® PRIME (MIM1024) chip (programmed by customer to operate third-party systems) | .RFID.LEGIC1024 |
| Version with additional LEGIC® Advant (128) chip (programmed by customer to operate third-party systems) | .RFID.ADVANT |
| Version with additional LEGIC® Advant (1024) chip (programmed by customer to operate third-party systems) | .RFID.ADVANT1024 |
| Version with additional LEGIC® Advant (4096) chip (programmed by customer to operate third-party systems) | .RFID.ADVANT4096 |
| Version approved for Explosion Protection Zone 1, certification: Intrinsic Safety ib, Zone 1, Group IIC, T3, II2G (for G1 only) | .EX |
| Version for fire service key tube with a minimum inner diameter of 33 mm | .FSR |
| Version with G2 functions for fire service key tube with a minimum inner diameter of 33 mm | .G2.FSR |
| Version to store lock system password (for G1 only) | .PWD |
| Switching transponder with two connection wires used to connect transponder to an isolated contact on an external device | .SCHALT |
| Switching transponder featuring G2 functions with two connection wires used to connect transponder to an isolated contact on an external device | .SCHALT.G2 |
| 10 lanyards High-quality transponder cord in a SimonsVoss design to hang around neck, with a metal clip to attach a transponder | TRA.BAND |
| 5 transponder housing with blue button without electronics | TRA.GH |
| 5 transponder housing with dark red button without electronics | TRA.GH.ROT |
| 5 transponder housing with brown button without electronics | TRA.GH.BRAUN |
| 5 batteries for transponder (type: CR2032) | TRA.BAT |

BIOMETRIC READER Q3008

G1

Also protect individual, restricted-access rooms with up to 50 users with the Q3008. Battery operated and installed without cabling, this reader is also highly suitable as a retrofit to existing 3060 systems. An ID is allocated to each finger scanned into the system. This allows users to operate all SimonsVoss locking components using their fingerprint. The Q3008 stores up to 50 different different finger prints and can be surface-mounted without any cabling.

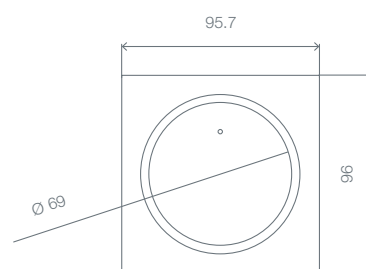

Measurements indicated in mm

TECHNICAL SPECIFICATIONS

- ⚡ Silver-coloured or white ABS plastic housing with POM insert
- ⚡ Biometric reader with an integrated fingerprint sensor
- ⚡ Dimensions: 96 x 95.7 x 21.5 mm (H x W x D)
- ⚡ Weight: about 115 g with battery
- ⚡ Not suitable for use outdoors when not protected
- ⚡ Typical read range: up to 40 cm to the locking cylinder/ Smart Handle; up to 120 cm to Smart Relay
- ⚡ Battery type: 1 x AA, 3.6V, lithium
- ⚡ Battery life: up to 70,000 lock operations or up to seven years on standby
- ⚡ Temperature range: -10 °C to +50 °C without condensation
- ⚡ Management of up to 50 users
- ⚡ Teach-in of user fingers controlled by master finger (optional)
- ⚡ Cable-free surface mount

PRODUCT VERSIONS

| | |
|---|---------------|
| Biometric Reader Q3008 Battery-operated, cabling-free biometric reader for mounting on wall, in silver-coloured housing, with integrated fingerprint sensor to manage up to 50 users | TRA.BIO.LESER |
| Version in white housing | .W |
| 1 battery for biometric reader (type: AA) | TRA.LESER.BAT |

PIN CODE KEYPAD 3068

PIN CODE TERMINAL 3068

G1 G2

Open your doors with a 4- to 8-digit-code. You can install the ultra-slim PIN Code keypad both indoors and outdoors and even attach it to glass. No wiring is required. Save time and costs by issuing a special code for the entrance door for events such as seminars and evening meetings.

You can achieve even greater security with the PIN code terminal, which can also be combined with the use of a transponder when the number combination is entered.

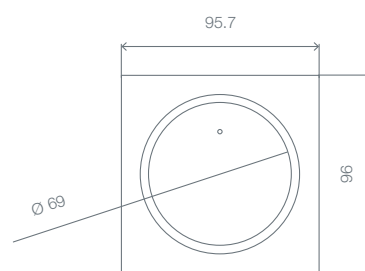

Measurements indicated in mm

TECHNICAL SPECIFICATIONS

PIN CODE KEYPAD/TERMINAL 3068

- ⌘ Silver-coloured ABS plastic housing
- ⌘ Dimensions: 96 x 95.7 x 14 mm (H x W x D)
- ⌘ Weight: about 100 g including batteries
- ⌘ Protection rating: IP65
- ⌘ Typical read range: up to 40 cm to the locking cylinder/ Smart Handle; up to 120 cm to Smart Relay
- ⌘ Battery type: 2 x CR2032, 3V, lithium
- ⌘ Battery life: up to 100,000 lock operations or up to ten years on standby
- ⌘ 2-level battery warning system
- ⌘ Temperature range: -25 °C to +65 °C
- ⌘ Manipulation alarm
- ⌘ Activation of the SimonsVoss activation unit
- ⌘ Number of keypad users: 3 different PINs
Number of terminal users: 500 different PINs
- ⌘ Cable-free surface mount
- ⌘ Received the IF Product Design Award 2006

PRODUCT VERSIONS

| | |
|---|-----------------|
| PIN Code Keypad 3068 (for G1 systems) Battery-operated, cable-free PIN code keypad as an identification medium in Digital Lock System 3060, 3 different PINs, silver-coloured ABS plastic housing, protection rating IP65 | TRA.PINCODE |
| PIN Code Terminal 3068 (for G2 systems) Battery-operated, cable-free PIN code terminal as an identification medium in Digital Lock System 3060, 500 different users, silver-coloured ABS plastic housing, protection rating IP65 | TRA.PC.TERMINAL |
| 5 batteries for PIN code keypad and PIN code terminal (type: CR 2032) | TRA.BAT |

SMART CLIP 3069

G1

Smart Clip 3069 is a card holder with an integrated SimonsVoss transponder. Plastic cards in ISO 7816 format can be inserted into the card holder, thus ensuring they are worn where they can be seen.

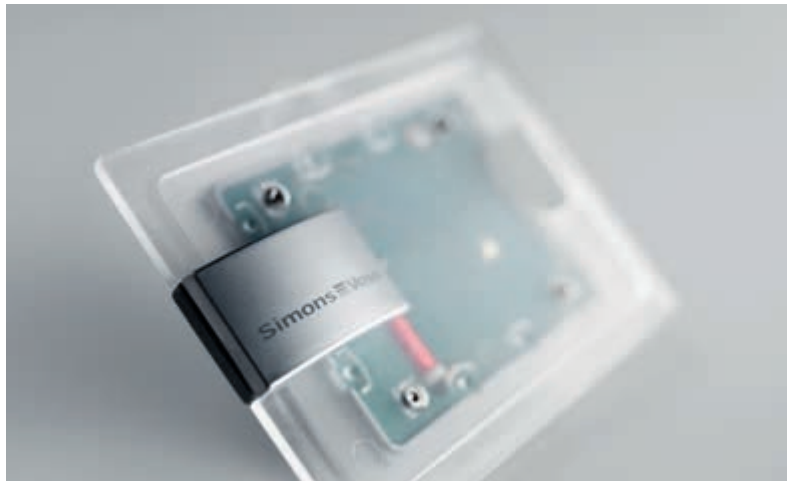

TECHNICAL SPECIFICATIONS

- ⚡ Casing made of transparent plastic with metallised plastic clasp (polycarbonate/polyamide)
- ⚡ Dimensions: 66 x 97.9 x 18 mm (H x W x D)
- ⚡ Weight: about 33 g with battery
- ⚡ Protection rating: IP 52
- ⚡ Typical read range: up to 40 cm to the locking cylinder/ Smart Handle; up to 120 cm to Smart Relay
- ⚡ Battery type: 1 x CR2032, 3V, lithium
- ⚡ Battery life: up to 1 million lock operations or up to ten years on standby
- ⚡ Temperature range: 0 °C to +60 °C
- ⚡ Received the IF Product Design Award 2006

PRODUCT VERSIONS

| | |
|---|---------|
| Smart Clip 3069 Transponder and card holder to display a card in ISO 7816 format, including clip; clip on left | TRA.DTC |
| Version with clip on right | .R |
| Version with pre-cut fastening slot | .S |
| 5 batteries for Smart Clip (type: CR2032) | TRA.BAT |

PROGRAMMING

Programming Device Smart CD

USB config device – G2



There are different options for offline programming, depending on the lock system size:

- ⚡ Small G1 lock systems can be configured without software using Programming Transponder 3067.
- ⚡ Small G2 lock systems can be configured using the USB config device in conjunction with the LSM-Starter software.
- ⚡ Large systems are managed with the Locking System Management software (LSM). The lock plan is produced on a PC. The data are then transferred to the digital components using Programming Device Smart CD
- ⚡ Alternatively, lock plans can be transferred to a PDA/netbook which communicates with the Smart CD using Bluetooth or USB.
- ⚡ Can also be programmed online; see Multi-networking.

TECHNICAL SPECIFICATIONS FOR SMART CD

- ⚡ Housing made of dark-grey polyamide
- ⚡ Dimensions: 112 x 63 x 22 mm (H x W x D)
- ⚡ Protection rating: IP 20
- ⚡ Battery type: 2 rechargeable li-ion manganese batteries
- ⚡ Recharged via USB port
- ⚡ Temperature range: -5 °C to +40 °C

TECHNICAL DATA FOR USB CONFIG DEVICE

- ⚡ Programming: SimonsVoss Active Technology, 25kHz
- ⚡ LSM version: LSM Starter
- ⚡ Operating system: Windows XP SP3 and higher
- ⚡ USB port: USB type A, USB 2.0
- ⚡ Dimensions: W x H x D - (57)70 x 19 x 13 mm
- ⚡ Read range: 10-30 cm
- ⚡ Power supply: via USB connector, no internal battery
- ⚡ Protection rating: IP40
- ⚡ Temperature range: -10 to +60°C
- ⚡ Humidity: 95% (non-condensing)

PROGRAMMING

Programming Transponder 3067 – G1

USB config device – G2



PRODUCT VERSIONS

Programming device

To connect to a USB port on a PC or laptop. Can be operated using Bluetooth on a Windows Mobile PDA (approved device: PDA.XX.DE) as a portable solution. Included in supply package: Programming Device Smart CD, CD ROM with manual and USB drivers, 2 integrated rechargeable batteries. Required software: a SimonsVoss lock plan software is always needed when used with a PC or laptop. LSM Mobile Edition is also required when used with a PDA.

SMART CD.G2

PDA

With Windows Mobile operating system and Bluetooth technology, in conjunction with Smart CD and LSM Mobile Edition as a programming device for System 3060 (SmartCD and LSM Mobile Edition are not included in the supplied package and must be ordered separately)

PDA.XX.DE

Netbook

With Windows 7 Starter operating system in conjunction with Smart CD and LSM Mobile Edition as a programming device for System 3060 (SmartCD and LSM Mobile Edition are not included in the supplied package and must be ordered separately)

NB.WM.ML

Programming Transponder 3067 (for G1)

For simple programming of cylinders and transponders in small lock systems (Smart CD/software is not needed)

CD.PROG

USB config device

To programme active components. To connect to a USB port on a PC. in conjunction with LSM Starter only.

CD.STARTER.G2

Als Gateway

Smart Relay 2 usable as a Gateway for virtual networking of active transponders, with access control, time zone control and events logging; connection available for SREL.AV. Relay contact as NOC contact (can be reversed to breaker contact). Only operate with DC current (9 to 24 V DC)

SREL2.ZK.G2.W

PROGRAMMING

Transponder terminal

The transponder terminal is a network-ready, vandal-proof, external programming device for use outdoors. It can automatically re-programme active SimonsVoss transponders without the locking system manager needing to be directly involved the programming process or be present in person on site. If a whole department moves, for example, all SimonsVoss lock system authorisation structures can be flexibly changed over time. The terminal can be used in offline systems and as an extension in virtual networks.



PRODUCT VERSIONS

Transponder terminal
Network-compatible, vandalism-resistant programming device for outdoor areas to reprogramme G2 transponders in offline or VN systems

TRATERM

ACTIVE TECHNOLOGY

DIGITAL LOCKING CYLINDER

3061



DIGITAL EURO PROFILE DOUBLE THUMB-TURN CYLINDER 3061 – FD

G1

G2

Digital Locking Cylinder 3061 is a true all-rounder. In addition to opening and closing locking devices, it also offers a large number of intelligent functions, such as access control with logging for up to 3,000 locking events, time zone control, event management and door monitoring, with the actual functions depending on the design fitted.

Integrated button cells provide power for up to 300,000 lock operations. As there is no wiring whatsoever, mounting and replacement is completed in next to no time, whether you are installing a cylinder for the first time or retrofitting. The cylinder can be operated offline, in a partially networked configuration or online in the WaveNet network.

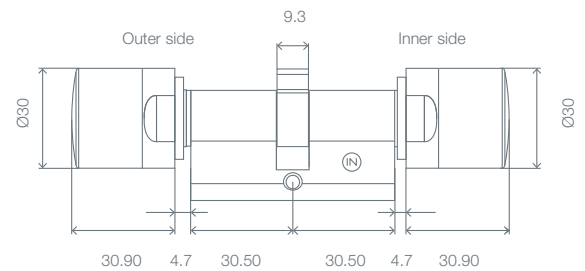

Measurements indicated in mm

TECHNICAL SPECIFICATIONS

- ⚡ Standard Euro Profile cylinder as per DIN 18252 / EN 1303 / DIN EN 15684, stainless steel design, freely rotating on both sides
- ⚡ Thumb-turn diameter: 30 mm
- ⚡ Basic installation length: 30-30 mm (external/inside dimension)
- ⚡ Overall length: up to 140 mm (max. 90 mm on one side); special lengths on request
- ⚡ Protection rating: IP54; .WP version: IP66
- ⚡ Battery type: 2 x lithium, CR2450, 3V
- ⚡ Battery life: up to 300,000 lock operations or up to ten years on standby
- ⚡ Temperature range: Operational: -25 °C to +65 °C
In storage: -35 °C to +50 °C
- ⚡ 3,000 access events can be saved
- ⚡ Time zone groups:
 - G1: 5+1
 - G2: 100+1
- ⚡ Number of transponders which can be managed per locking cylinder:
 - G1: up to 8,000
 - G2: up to 64,000
- ⚡ Number of locking devices which can be managed per transponder.
 - G1: up to 48,000
 - G2: up to 304,000
- ⚡ G1: Different permanent/open modes
- ⚡ Can be directly networked with integrated Lock Node (Network Thumb-turn Cover WNM.LN.I) or via external Lock Node with additional door monitoring function
- ⚡ Can be used as a gateway, freely configurable (recommended for small locking systems only; G2 version only)

DIGITAL EURO PROFILE
DOUBLE THUMB-TURN CYLINDER
3061 – FD

Version with button control

Brass design



PRODUCT VERSIONS

| | |
|--|----------------|
| Digital Euro Profile Double Thumb-turn Cylinder 3061 – FD Installation length 30-30 mm, freely rotating, stainless design | Z4.30-30.FD |
| Digital Euro Profile Double Thumb-turn Cylinder 3061 – FD with G2 functions Installation length 30-30 mm, freely rotating, stainless design | Z4.30-30.FD.G2 |
| Brass design | .MS |
| Version with access control, time zone management and events logging | .ZK |
| Version with button control (operated on the inside without transponder), not available with G2 functions | .TS |
| Version with VdS approval, Class AZ, SKG approval SKG*** | .SKG |
| Version in VdS design Version with access control, time zone control and event logging, VdS approval, Class BZ, SKG approval SKG***, together with the block lock function in a installation Can be used up to Class VdS C/SG 6 | .ZK.VDS |
| Multi-point version For use in doors with multi-point locks, from installation length 35-30 mm | .MR |
| Fire-retardant version For use in steel and fire doors | .FH |
| Weatherproof version Protection rating IP66, from installation length 35-30 mm, not supplied in combination with .TS, .MR and VdS versions | .WP |
| 'Network Inside' version with integrated Lock Node | WNM.LN.I |

INSTALLATION LENGTHS (all length specifications: external - inside):

| | |
|---|------------------|
| Overall length from 65 mm to 80 mm | e.g. Z4.40-40.FD |
| Overall length over 80 mm to 100 mm | e.g. Z4.40-60.FD |
| Overall length over 100 mm up to max. 140 mm (max. 90 mm on one side) | e.g. Z4.65-75.FD |
| Overall length over 140 mm or over 90 mm on one side | on request |

DIGITAL EURO PROFILE DOUBLE THUMB-TURN CYLINDER 3061 – ANTI-PANIC

G1

G2

The anti-panic cylinder has been specially developed for use along escape and rescue routes. The new AP2 cylinder is freely rotating on both sides, so that the lock can be locked and unlocked from both sides using an authorised transponder. In a panic situation, however, the door can be opened without a transponder using the anti-panic lock function. It may only be fitted into locks which list the cylinder in their approval.

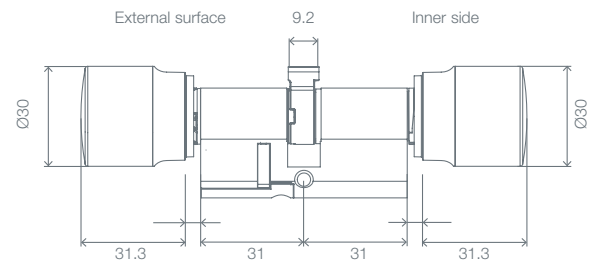
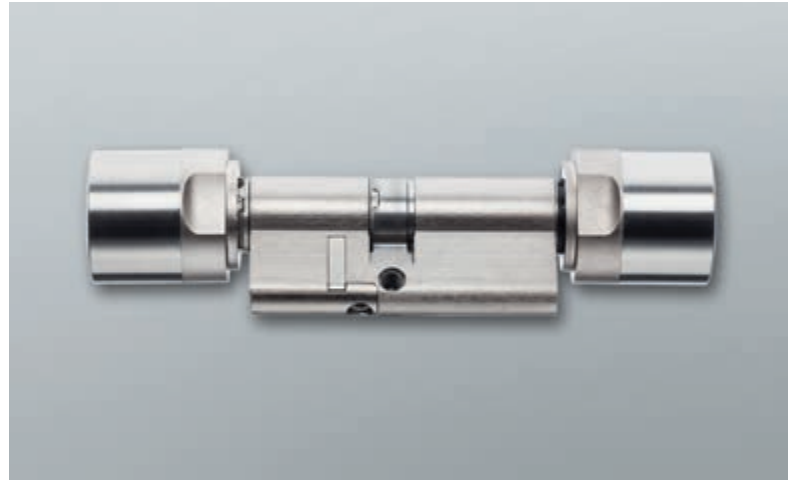

Measurements indicated in mm

TECHNICAL SPECIFICATIONS

- ⚡ Euro Profile anti-panic cylinder as per DIN 18252 / EN 1303 / DIN EN 15684
- ⚡ Thumb-turn diameter: 30 mm
- ⚡ Basic installation length: 30–30 mm (external/inside dimension)
- ⚡ Overall length: up to 140 mm (max. 90 mm on one side); special lengths on request
- ⚡ Protection rating: IP54; .WP version (electronic thumb-turn): IP66
- ⚡ Battery type: 2 x lithium, CR2450, 3V
- ⚡ Battery life: up to 300,000 lock operations or up to ten years on standby
- ⚡ Temperature range: Operational: -25 °C to +65 °C
In storage: -35 °C to +50 °C
- ⚡ 3,000 access events can be saved
- ⚡ Time zone groups:
 - G1: 5+1
 - G2: 100+1
- ⚡ Number of transponders which can be managed per locking cylinder:
 - G1: up to 8,000
 - G2: up to 64,000
- ⚡ Number of locking devices which can be managed per transponder.
 - G1: up to 48,000
 - G2: up to 304,000
- ⚡ G1: Different permanent/open modes
- ⚡ Can be directly networked with integrated Lock Node (Network Thumb-turn Cover WNM.LN.I) or via external Lock Node with additional door monitoring function
- ⚡ Can be used as a gateway, freely configurable (recommended for small locking systems only)

DIGITAL EURO PROFILE
DOUBLE THUMB-TURN CYLINDER
3061 – ANTI-PANIC

PRODUCT VERSIONS

| | |
|---|------------------------|
| Digital Euro Profile Double Thumb-turn Cylinder 3061 – Anti-Panic Installation length 30-30 mm, for use in anti-panic locks, freely rotating on both sides, stainless steel design | Z4.30-30.AP2.FD |
| Digital Euro Profile Double Thumb-turn Cylinder 3061 – Anti-panic with G2 functions Installation length 30-30 mm, for use in anti-panic locks, freely rotating on both sides, stainless steel design | Z4.30-30.AP2.FD.G2 |
| Digital Euro Profile Double Thumb-turn Cylinder 3061 – Anti-Panic Installation length 30-35 mm, for use in anti-panic locks; inside thumb-turn is always engaged; stainless steel design | Z4.30-35.AP |
| Digital Euro Profile Double Thumb-turn Cylinder 3061 – Anti-panic with G2 functions Installation length 30-35 mm, for use in anti-panic locks; inside thumb-turn is always engaged; stainless steel design | Z4.30-35.AP.G2 |
| Brass design | .MS |
| Version with access control, time zone management and events logging | .ZK |
| Weatherproof version, protection rating IP66 (electronic thumb-turn) | .WP |
| Version with VdS design, installation length 30-35 mm (AP2 only) | .ZK.VDS |
| Version with button control (operated on the inside without transponder [for G1 and AP2 only]) | .TS |
| Fire-retardant version, for use in steel and fire doors (AP2 only) | .FH |
| Version without inside thumb-turn (inside length is always 35 mm) | .OK |
| 'Network Inside' version with integrated lock node | WNM.LN.I |
| INSTALLATION LENGTHS (all length specifications: external - inside): | |
| Overall length of 65 mm (AP2) or 70 mm (AP) to 80 mm | e.g. Z4.40-40.AP / AP2 |
| Overall length over 80 mm to 100 mm | e.g. Z4.40-55.AP / AP2 |
| Overall length over 100 mm up to max. 140 mm (max. 90 mm on one side) | e.g. Z4.50-55.AP / AP2 |
| Overall length over 140 mm or over 90 mm on one side | on request |

DIGITAL EURO PROFILE DOUBLE THUMB-TURN CYLINDER 3061 – COMFORT

G1

G2

Digital locking cylinder with an enclosed electronics assembly as per DIN 18252 / DIN EN 15684 / EN 1303 for fitting into Euro profile locks as per DIN 18251. Approval for fitting into locks as per DIN 18250 (fire protection).

- ⌘ Internal side is permanently engaged
- ⌘ Freely programmable
- ⌘ Active transponder used as medium
- ⌘ Access control, time zone management and events logging
- ⌘ Versions with protection rating IP66
- ⌘ Can be directly networked with a retrofit replacement thumb-turn cover

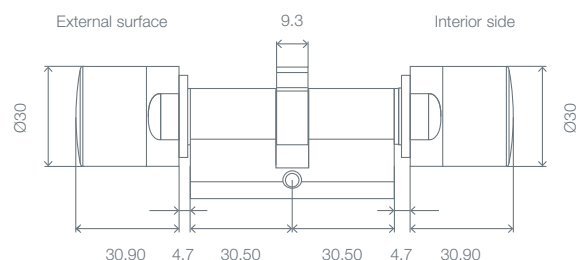

Measurements indicated in mm

TECHNICAL SPECIFICATIONS

- ⌘ Standard Euro Profile cylinder as per DIN 18252 / EN 1303 / DIN EN 15684
- ⌘ Thumb-turn diameter: 30 mm
- ⌘ Basic installation length: 30–30 mm (external/inside dimension)
- ⌘ Overall length: up to 140 mm (max. 90 mm on one side); special lengths on request
- ⌘ Protection rating: IP54; .WP version IP66
- ⌘ Battery type: 2 x lithium, CR2450, 3V
- ⌘ Battery life: up to 300,000 lock operations or up to ten years on standby
- ⌘ Temperature range: Operational: -25 °C to +65 °C
In storage: -35 °C to +50 °C
- ⌘ 3,000 access events can be saved
- ⌘ Time zone groups:
 - G1: 5+1
 - G2: 100+1
- ⌘ Number of transponders which can be managed per locking cylinder:
 - G1: up to 8,000
 - G2: up to 64,000
- ⌘ Number of locking devices which can be managed per transponder.
 - G1: up to 48,000
 - G2: up to 304,000
- ⌘ G1: Different permanent/open modes
- ⌘ Can be directly networked with integrated Lock Node (Network Thumb-turn Cover WNM.LN.I) or via external Lock Node with additional door monitoring function
- ⌘ Can be used as a gateway, freely configurable (recommended for small locking systems only)

DIGITAL EURO PROFILE
DOUBLE THUMB-TURN CYLINDER
3061 – COMFORT

PRODUCT VERSIONS

| | |
|---|----------------|
| Digital Euro Profile Double Thumb-turn Cylinder 3061 – Comfort Installation length 30-30 mm; non-electronics side is permanently engaged, so can be opened from the inside without transponder, stainless steel design | Z4.30-30.CO |
| Digital Euro Profile Double Thumb-turn Cylinder 3061 – Comfort with G2 functions Installation length 30-30 mm; non-electronics side is permanently engaged, so can be opened from the inside without transponder, stainless steel design | Z4.30-30.CO.G2 |
| Brass design | .MS |
| Version with access control, time zone management and events logging | .ZK |
| Weatherproof version, protection rating IP66 | .WP |
| Seawater-proof version (supplied in conjunction with .WP version only) | .SW |
| 'Network Inside' version with integrated Lock Node | WNM.LN.I |

INSTALLATION LENGTHS (all length specifications: external - inside):

| | |
|---|------------------|
| Overall length from 65 mm to 80 mm | e.g. Z4.40-40.CO |
| Overall length over 80 mm to 100 mm | e.g. Z4.40-60.CO |
| Overall length over 100 mm up to max. 140 mm (max. 90 mm on one side) | e.g. Z4.65-75.CO |
| Overall length over 140 mm or over 90 mm on one side | on request |

DIGITAL EURO PROFILE DOUBLE THUMB-TURN CYLINDER 3061 – DOOR MONITORING

G2

Digital Locking Cylinder 3061 is setting completely new benchmarks in building security with its door monitoring design. Besides a locking and access control function, this cylinder also offers you a compact door monitoring system. A sensor in the fastening screw reliably monitors the door status and any changes to this status. Information is actively forwarded to the LSM Locking System Management software via the WaveNet, indicating whether the door is open or closed, the bolt is completely retracted or extended, the door has been locked once or double locked or has been open too long. This information is then processed further.

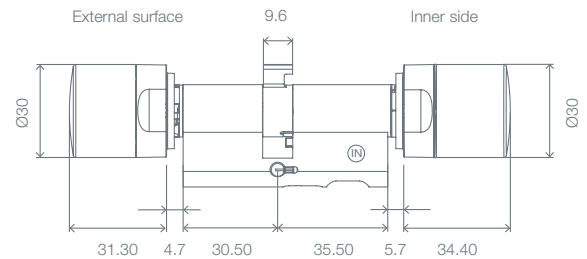
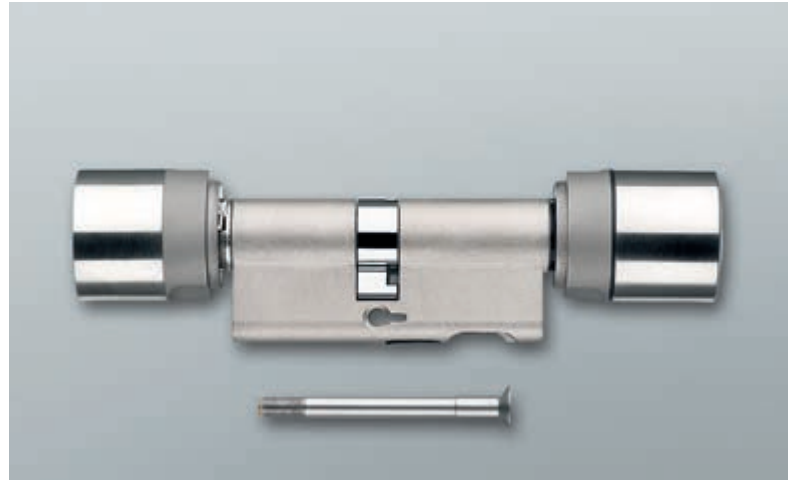

Measurements indicated in mm

- ⚡ Standard Euro profile cylinder as per DIN 18252 / EN1303 / DIN EN 15684 / EN 1303 for fitting into Euro profile locks as per DIN 18251. Approval for fitting into locks as per DIN 18250
- ⚡ Cable-free door monitoring
- ⚡ Easy to retrofit, easy to install
- ⚡ Use mouse to access overview showing status of monitored doors
- ⚡ Reporting of critical events such as attempted manipulation and non-locking of doors to restricted access areas and similar
- ⚡ Seamless integration into the SimonsVoss solutions portfolio

MODE OF OPERATION

The monitoring cylinder is based on the existing standard FD Cylinder and has been equipped with the following new functions:

Detection of the door opening status via a sensor in the fastening screw

- ⚡ A permanent magnet is attached to the door frame. The external magnetic field is detected by the sensor in the fastening screw.

Locking status detected via the cam

- ⚡ A sensor in the cylinder monitors cam rotations and detects the position of the dead bolt

Capturing and processing information

- ⚡ The electronics in the thumb-turn processes all information and either saves it and/or forwards it to the LSM via the WaveNet

Analysis by LSM

- ⚡ The current door statuses in all door monitoring cylinders are displayed in the matrix in LSM*
- ⚡ Each status change in all door monitoring cylinders in a locking system is recorded in a list
- ⚡ Alarms can be transmitted by email, mobile text message or a pop-up window in conjunction with an event agent during the monitoring period.* These can alert to events such as door manipulation, unauthorised access attempts or when door opening intervals are exceeded

* In conjunction with LSM Business or LSM Professional only

DIGITAL EURO PROFILE
DOUBLE THUMB-TURN CYLINDER
3061 – DOOR MONITORING

RECORDING OF MONITORING DATA

The Door Monitoring Cylinder records the following information:

- ⌘ Door open or closed
- ⌘ Detection of an attempted break-in/manipulation with an external magnet involving a locked door
- ⌘ Door bolted or securely locked
- ⌘ Cylinder opened by authorised transponder
- ⌘ Attempted entry using a non-authorised transponder
- ⌘ Logging of date and time

SYSTEM SPECIFICATIONS AND INTERDEPENDENCIES WITH OTHER PRODUCTS

LSM (Version 3.2 and higher)

- ⌘ LSM Basic (only possible to log door statuses)
- ⌘ LSM Business or LSM Professional for online monitoring together with LSM Network xx, LSM Online
- ⌘ Optional LSM DM Calibrate to help install the Door Monitoring Cylinder

Network

- ⌘ The WaveNet network is required for online monitoring

Miscellaneous

- ⌘ An intelligent fastening screw must be ordered to accompany the cylinder, the length of which depends on the backset

TECHNICAL SPECIFICATIONS

- ⌘ Euro Profile Door Monitoring Cylinder as per DIN 18252 / EN 1303 / DIN EN 15684, stainless steel design, freely rotating on both sides
- ⌘ Thumb-turn diameter: 30 mm
- ⌘ Basic installation length: 30-35 mm (external/inside dimension)
- ⌘ Overall length: up to 140 mm (max. 90 mm on one side); special lengths on request
- ⌘ Protection rating: IP54; .WP version (electronic thumb-turn): IP 66
- ⌘ Battery type: 2 x lithium, CR2450, 3V
- ⌘ Temperature range: Operational: -25 °C to +65 °C
In storage: -35 °C to +50 °C
- ⌘ About 800 door statuses can be stored
- ⌘ Time zone groups: 100+1
- ⌘ Up to 64,000 transponders can be managed per locking cylinder
- ⌘ Up to 304,000 locking devices can be managed per transponder
- ⌘ Network-ready directly with integrated Lock Node (Network Thumb-turn Cover WNM.LN.I)

DIGITAL EURO PROFILE
DOUBLE THUMB-TURN CYLINDER
3061 – DOOR MONITORING

PRODUCT VERSIONS

| | |
|---|--|
| Digital Euro Profile Double Thumb-turn Cylinder 3061 – Door Monitoring with G2 functions Installation length 30–30 mm, freely rotating on both sides, including access control, time zone control and event logging, stainless steel design; can only be used in conjunction with intelligent fastening screw, which must be ordered separately. | Z4.30-35.DM.FD.ZK.G2 |
| Intelligent fastening screw for Door Monitoring Cylinder | See under Accessories for active cylinders |
| Brass design | .MS |
| Weatherproof version, protection rating IP66 (electronic thumb-turn) | .WP |
| Fire-retardant version for use in steel and fire doors | .FH |
| Multi-point version for use in doors with multi-point locks, from installation length of 35-35 mm | .MR |
| INSTALLATION LENGTHS (all length specifications: external - inside): | |
| Overall length from 70 mm to 80 mm | e.g. Z4.40-40.DM.FD |
| Overall length over 80 mm to 100 mm | e.g. Z4.40-60.DM.FD |
| Overall length over 100 mm up to max. 140 mm (max. 90 mm on one side) | e.g. Z4.65-75.DM.FD |
| Overall length over 140 mm or over 90 mm on one side | on request |

DIGITAL EURO PROFILE HALF CYLINDER 3061

G1

G2

Digital half cylinder with an enclosed electronics assembly as per DIN 18252 / DIN EN 15684 / EN 1303 for fitting into Euro profile locks as per DIN 18251 for special applications, such as use on garage doors or in lockers:

- ⌘ Freely programmable
- ⌘ Active transponder used as medium
- ⌘ Access control, time zone management and events logging
- ⌘ Versions with protection rating IP66
- ⌘ Can be directly networked with a retrofit replacement thumb-turn cover

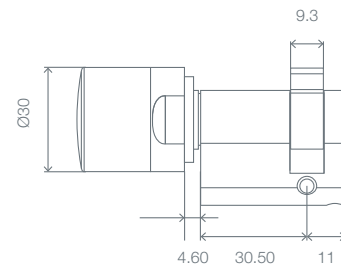

Measurements indicated in mm

TECHNICAL SPECIFICATIONS

- ⌘ Standard Euro Profile cylinder as per DIN 18252 / EN 1303 / DIN EN 15684
- ⌘ Thumb-turn diameter: 30 mm
- ⌘ Basic installation length: 30-10 mm
- ⌘ Overall length: up to 100 mm (outside max. 90 mm); special lengths on request
- ⌘ Protection rating: IP54; .WP version (Thumb-turn): IP 66
- ⌘ Battery type: 2 x lithium, CR2450, 3V
- ⌘ Battery life: up to 300,000 lock operations or up to ten years on standby
- ⌘ Temperature range: Operational: -25 °C to +65 °C
Storage -35 °C to +50 °C
- ⌘ 3,000 access events can be saved
- ⌘ Time zone groups:
 - G1: 5+1
 - G2: 100+1
- ⌘ Number of transponders which can be managed per locking cylinder:
 - G1: up to 8,000
 - G2: up to 64,000
- ⌘ Number of locking devices which can be managed per transponder.
 - G1: up to 48,000
 - G2: up to 304,000
- ⌘ G1: Different permanent/open modes
- ⌘ Can be directly networked with integrated Lock Node (Network Thumb-turn Cover WNM.LN.I) or via external lock node with additional door monitoring function
- ⌘ Can be used as a gateway, freely configurable (recommended for small locking systems only)

DIGITAL EURO PROFILE
HALF CYLINDER 3061

PRODUCT VERSIONS

| | |
|--|----------------|
| Digital Euro Profile Half Cylinder 3061 Installation length 30-10 mm; thumb-turn not detachable, stainless steel design | Z4.30-10.HZ |
| Digital Euro Profile Half Cylinder 3061 with G2 functions Installation length 30-10 mm; thumb-turn not detachable, stainless steel design | Z4.30-10.HZ.G2 |
| Brass design | .MS |
| Version with access control, time zone management and events logging | .ZK |
| Version with detachable thumb-turn (e.g. for fitting behind cover plates without profile cylinder perforation) | .DK |
| Half cylinder in multi-point design; thumb-turn detachable | .MR |
| Weatherproof version, protection rating IP66 (Thumb-turn) | .WP |
| 'Network Inside' version with integrated Lock Node | WNM.LN.I |
| Version with shortened range | .VR |

INSTALLATION LENGTHS (all length specifications: external - inside):

| | |
|--|------------------|
| Overall length from 45 mm to 70 mm | e.g. Z4.60-10.HZ |
| Overall length over 70 mm up to 100 mm (max. 90 mm on outside) | e.g. Z4.80-10.HZ |
| Installation length over 90 mm on outside | on request |

DIGITAL EURO PROFILE HALF CYLINDER 3061 – DOOR MONITORING

G2

Digital Locking Cylinder 3061 is setting new benchmarks in building security thanks to its door monitoring design. Besides a locking and access control function, this cylinder also offers you a compact door monitoring system. A sensor in the fastening screw reliably monitors the door status and any changes to this status. Information is actively forwarded to the LSM Locking System Management software via the WaveNet, indicating whether the door is open or closed, the bolt is completely retracted or extended, the door has been locked once or double locked or has been open too long. This information is then processed further.

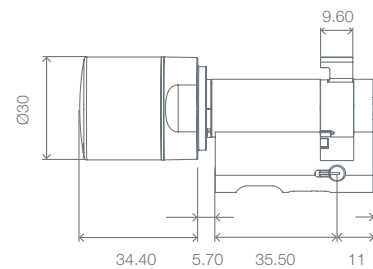

Measurements indicated in mm

TECHNICAL SPECIFICATIONS

- ⚡ Euro Profile Door Monitoring Half Cylinder as per DIN 18252 / EN 1303 / DIN EN 15684, stainless steel design, freely rotating on the outside
- ⚡ Thumb-turn diameter: 30 mm
- ⚡ Basic installation length: 35-10 mm (external/inside dimension)
- ⚡ Overall length: up to 100 mm (max. 90 mm on one side); special lengths on request
- ⚡ Protection rating: IP54; .WP version (thumb-turn): IP66
- ⚡ Battery type: 2 x lithium, CR2450, 3V
- ⚡ Temperature range: Operational: -25 °C to +65 °C
In storage: -35 °C to +50 °C
- ⚡ About 800 door statuses can be stored
- ⚡ Time zone groups: 100+1
- ⚡ Up to 64,000 transponders can be managed per locking cylinder
- ⚡ Up to 304,000 locking devices can be managed per transponder
- ⚡ Network-ready with integrated Lock Node (Network Thumb-turn Cover WNM.LN.I)

DIGITAL EURO PROFILE
 HALF CYLINDER 3061 –
 DOOR MONITORING

PRODUCT VERSIONS

| | |
|--|--|
| Digital Euro Profile Half Cylinder 3061 – Door Monitoring with G2 functions Installation length 35-10 mm; thumb-turn not detachable; thumb-turn: IP66; includes access control, time zone control and event logging, stainless steel design; can only be used in conjunction with intelligent fastening screw, which must be ordered separately. | Z4.35-10.DM.HZ.ZK.G2 |
| Intelligent fastening screw for door monitoring cylinder | See under Accessories for active cylinders |
| Brass design | .MS |
| Weatherproof version, protection rating IP66 (thumb-turn) | .WP |
| 'Network Inside' version with integrated Lock Node | WNM.LN.I |
| INSTALLATION LENGTHS (all length specifications: external - inside): | |
| Overall length from 50 mm to 70 mm | e.g. Z4.60-10.HZ |
| Overall length over 70 mm up to 100 mm (max. 90 mm on outside) | e.g. Z4.80-10.HZ |
| Installation length over 90 mm on outside | on request |

DIGITAL SCANDINAVIAN OVAL CYLINDER 3061

G1

G2

Digital locking cylinder with an enclosed electronics assembly as per DIN EN 15684 / EN 1303 for fitting into doors with a Scandinavian oval profile:

- ⌘ Freely programmable
- ⌘ Active transponder used as medium
- ⌘ Optional access control, events logging and time zone management
- ⌘ Versions with protection rating IP66
- ⌘ Can be directly networked with a retrofit replacement thumb-turn cover

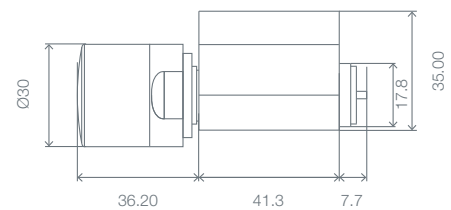

Measurements indicated in mm

TECHNICAL SPECIFICATIONS

- ⌘ Scandinavian Oval Profile Cylinder
- ⌘ Thumb-turn diameter: 30 mm
- ⌘ Basic installation length: in the version for the outer side: 41.3 mm; in the version for the inner side: 30 mm
- ⌘ Overall length: max. 86.3 mm; special lengths on request
- ⌘ Protection rating: inner thumb-turn: IP54; weatherproof version of cylinder for the outer side: IP66
- ⌘ Battery type: 2 x lithium, CR2450, 3V
- ⌘ Battery life: up to 300,000 lock operations or up to ten years on standby
- ⌘ Temperature range: Operational: -25 °C to +65 °C
In storage: -35 °C to +50 °C
- ⌘ 3,000 access events can be saved
- ⌘ Time zone groups:
 - G1: 5+1
 - G2: 100+1
- ⌘ Number of transponders which can be managed per locking cylinder:
 - G1: up to 8,000
 - G2: up to 64,000
- ⌘ Number of locking devices which can be managed per transponder.
 - G1: up to 48,000
 - G2: up to 304,000
- ⌘ G1: Different permanent/open modes
- ⌘ Network-ready with integrated Lock Node (Network Thumb-turn Cover WNM.LN.I) or via external Lock Node with additional door monitoring function
- ⌘ Can be used as gateway, freely configurable (recommended for smaller lock systems only)

DIGITAL SCANDINAVIAN OVAL CYLINDER 3061

PRODUCT VERSIONS

| | |
|--|--------------|
| Digital Scandinavian Oval Cylinder 3061 For the outer side: installation length 41.3 mm, stainless steel design | Z4.SO.A40 |
| Digital Scandinavian Oval Cylinder 3061 with G2 functions For the outer side: installation length 41.3 mm, stainless steel design | Z4.SO.A40.G2 |
| Digital Scandinavian Oval Cylinder 3061, operable without a transponder For the inner side: installation length 31.9 mm, stainless steel design | Z4.SO.I30 |
| Version with access control, time zone management and events logging | .ZK |
| Weatherproof version, protection rating IP66 (cylinder for the outer side) | .WP |
| Seawater-proof version | .SW |
| 'Network Inside' version with integrated Lock Node | WNM.LN.I |

INSTALLATION LENGTHS (all length specifications: external - inside):

| | |
|---|----------------|
| Installation length 61.3 mm per profile | e.g. Z4.SO.A60 |
| Installation length up to 86.3 mm per profile | e.g. Z4.SO.A80 |
| Installation length over 86.3 mm | on request |

ACCESSORIES

Extension Set SO and RS Cylinder. The set allows you to extend the cam in a Scandinavian cylinder by up to 75 mm.
Contents: 5 sets

Z4.SO.EXT.5

DIGITAL SCANDINAVIAN ROUND CYLINDER 3061

G1

G2

Digital locking cylinder with an enclosed electronics assembly as per DIN EN 15684 / EN 1303 for fitting into doors with a Scandinavian round profile:

- ⌘ Freely programmable
- ⌘ Active transponder used as medium
- ⌘ Optional access control, events logging and time zone management
- ⌘ Versions with protection rating IP66
- ⌘ Can be directly networked with a retrofit replacement thumb-turn cover

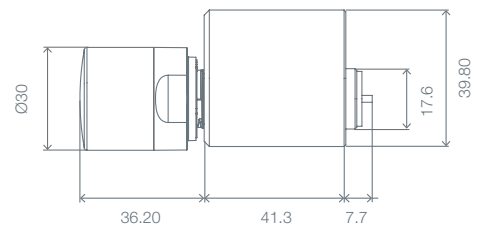
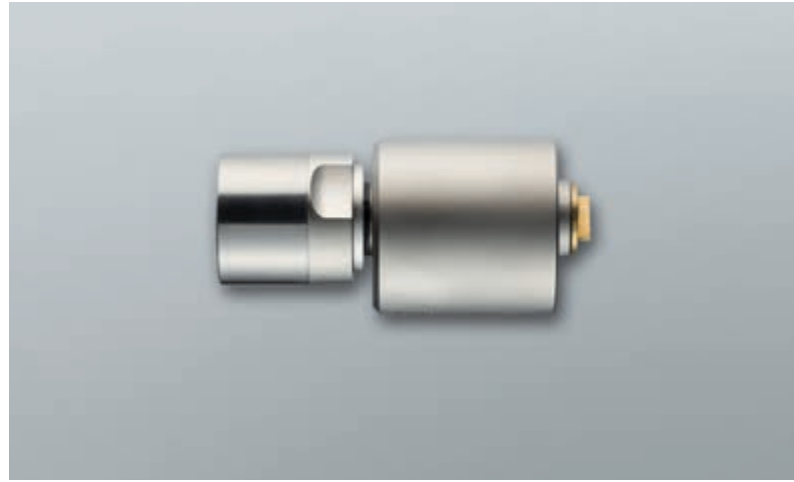

Measurements indicated in mm

TECHNICAL SPECIFICATIONS

- ⌘ Scandinavian Round Profile Cylinder
- ⌘ Thumb-turn diameter: 30 mm
- ⌘ Basic installation length: in the version for the outer side: 41.3 mm; in the version for the inner side: 30 mm
- ⌘ Overall length: max. 86.3 mm; special lengths on request
- ⌘ Protection rating: inside thumb-turn IP 54, weatherproof version IP 66
- ⌘ Battery type: 2 x lithium, CR2450, 3V
- ⌘ Battery life: up to 300,000 locking operations or up to ten years on standby
- ⌘ Temperature range: Operational: -25 °C to +65 °C
In storage: -35 °C to +50 °C
- ⌘ 3,000 access events can be saved
- ⌘ Time zone groups:
 - G1: 5+1
 - G2: 100+1
- ⌘ Number of transponders which can be managed per locking cylinder:
 - G1: up to 8,000
 - G2: up to 64,000
- ⌘ Number of locking devices which can be managed per transponder.
 - G1: up to 48,000
 - G2: up to 304,000
- ⌘ Can be directly networked with integrated Lock Node (Network Thumb-turn Cover WNM.LN.I) or via external lock node with additional door monitoring function
- ⌘ Can be used as gateway in small systems, freely configurable

DIGITAL SCANDINAVIAN ROUND CYLINDER 3061

PRODUCT VERSIONS

| | |
|--|--------------|
| Digital Scandinavian Oval Cylinder 3061, for the outer side, installation length 41.3 mm, stainless steel design | Z4.RS.A40 |
| Digital Scandinavian Oval Cylinder 3061 with G2 functions, for the outer side, installation length 41.3 mm, stainless steel design | Z4.RS.A40.G2 |
| Digital Scandinavian Oval Cylinder 3061, operable without a transponder, for the inner side, installation length 31.9 mm, stainless steel design | Z4.RS.I30 |
| Version with access control, time zone management and events logging | .ZK |
| Weatherproof version, protection rating IP66 (cylinder for outer side) | .WP |
| 'Network Inside' version with integrated Lock Node | WNM.LN.I |

INSTALLATION LENGTHS (all length specifications: external - inside):

| | |
|--|----------------|
| Overall length 61.3 mm per profile | e.g. Z4.RS.A60 |
| Overall length up to 86.3 mm per profile | e.g. Z4.RS.A80 |
| Installation length over 86.3 mm per profile | on request |

ACCESSORIES

| | |
|---|-------------|
| Extension Set SO and RS Cylinder. The set allows you to extend the cam in a Scandinavian cylinder by up to 75 mm. Contents: 5 sets | Z4.SO.EXT.5 |
|---|-------------|

DIGITAL BRITISH OVAL DOUBLE THUMB-TURN CYLINDER 3061

G1

G2

Digital locking cylinder with an enclosed electronics assembly as per DIN EN 15684 / EN 1303 for fitting into doors with a British oval profile:

- ⌘ Freely programmable
- ⌘ Active transponder used as medium
- ⌘ Optional access control, events logging and time zone management
- ⌘ Versions with protection rating IP66
- ⌘ Can be directly networked with a retrofit replacement thumb-turn cover

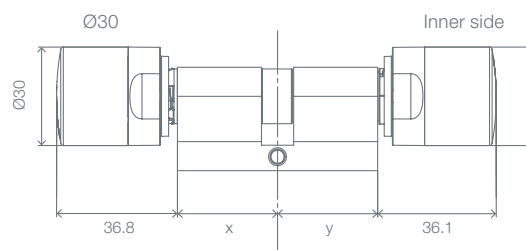

Measurements indicated in mm

TECHNICAL SPECIFICATIONS

- ⌘ British Oval Profile Cylinder
- ⌘ Thumb-turn diameter: 30 mm, freely rotating on both sides
- ⌘ Basic installation length: 30–30 mm (external/inside dimension)
- ⌘ Overall length: max. 140 mm (max. 90 mm on one side); special lengths on request
- ⌘ Protection rating: IP54; .WP version (electronic thumb-turn): IP66
- ⌘ Battery type: 2 x lithium, CR2450, 3V
- ⌘ Battery life: up to 300,000 lock operations or up to ten years on standby
- ⌘ Temperature range: Operational: -25 °C to +65 °C
Storage -35 °C to +50 °C
- ⌘ 3,000 access events can be saved
- ⌘ Time zone groups:
 - G1: 5+1
 - G2: 100+1
- ⌘ Number of transponders which can be managed per locking cylinder:
 - G1: up to 8,000
 - G2: up to 64,000
- ⌘ Number of locking devices which can be managed per transponder.
 - G1: up to 48,000
 - G2: up to 304,000
- ⌘ G1: Different permanent/open modes
- ⌘ Can be directly networked with integrated Lock Node (Network Thumb-turn Cover WNM.LN.I) or via external lock node with additional door monitoring function
- ⌘ Can be used as a gateway, freely configurable (recommended for small locking systems only)

DIGITAL BRITISH OVAL
DOUBLE THUMB-TURN CYLINDER
3061

PRODUCT VERSIONS

| | |
|---|-------------------|
| Digital British Oval Cylinder 3061 Installation length 30–30 mm, freely rotating on both sides, stainless design | Z4.BO.30-30.FD |
| Digital British Oval Cylinder 3061 with G2 functions Installation length 30–30 mm, freely rotating on both sides, stainless design | Z4.BO.30-30.FD.G2 |
| Version with access control, time zone management and events logging | .ZK |
| Version with button control (operated on the inside without transponder), not available with G2 functions | .TS |
| Fire-retardant version For use in steel and fire doors | .FH |
| Weatherproof version, protection rating IP66 (electronic thumb-turn) | .WP |
| 'Network Inside' version with integrated Lock Node | WNM.LN.I |

INSTALLATION LENGTHS (all length specifications: external - inside):

| | |
|---|---------------------|
| Overall length from 65 mm to 80 mm | e.g. Z4.BO.40-40.FD |
| Overall length from 85 mm to 100 mm | e.g. Z4.BO.40-60.FD |
| Overall length over 105 mm up to max. 140 mm (max. 90 mm on one side) | e.g. Z4.BO.65-75.FD |
| Overall length over 140 mm or over 90 mm on one side | on request |

DIGITAL BRITISH OVAL DOUBLE THUMB-TURN CYLINDER 3061 – COMFORT

G1

G2

Digital locking cylinder with an enclosed electronics assembly as per DIN EN 15684 / EN 1303 for fitting into doors with a British oval profile:

- ⌘ Freely programmable
- ⌘ Active transponder used as medium
- ⌘ Optional access control, events logging and time zone management
- ⌘ Versions with protection rating IP66
- ⌘ Can be directly networked with a retrofit replacement thumb-turn cover

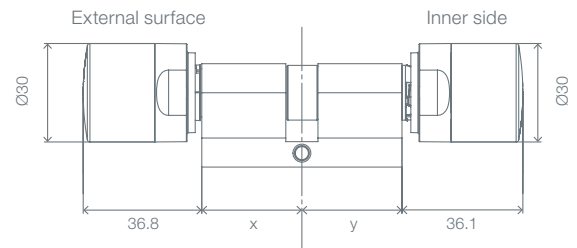

Measurements indicated in mm

TECHNICAL SPECIFICATIONS

- ⌘ British Oval Profile Cylinder Comfort, inner thumb-turn can be operated without transponder
- ⌘ Thumb-turn diameter: 30 mm
- ⌘ Basic installation length: 30–30 mm (external/inside dimension)
- ⌘ Overall length: max. 140 mm (max. 90 mm on one side); special lengths on request
- ⌘ Protection rating: IP54; .WP version (electronic thumb-turn): IP66
- ⌘ Battery type: 2 x lithium, CR2450, 3V
- ⌘ Battery life: up to 300,000 lock operations or up to ten years on standby
- ⌘ Temperature range: Operational: -25 °C to +65 °C
Storage -35 °C to +50 °C
- ⌘ 3,000 access events can be saved
- ⌘ Time zone groups:
 - G1: 5+1
 - G2: 100+1
- ⌘ Number of transponders which can be managed per locking cylinder:
 - G1: up to 8,000
 - G2: up to 64,000
- ⌘ Number of locking devices which can be managed per transponder.
 - G1: up to 48,000
 - G2: up to 304,000
- ⌘ G1: Different permanent/open modes
- ⌘ Can be directly networked with integrated Lock Node (Network Thumb-turn Cover WNM.LN.I) or via external lock node with additional door monitoring function
- ⌘ Can be used as a gateway, freely configurable (recommended for small locking systems only)

DIGITAL BRITISH OVAL
DOUBLE THUMB-TURN CYLINDER
3061 – COMFORT

PRODUCT VERSIONS

| | |
|--|-------------------|
| Digital British Oval Cylinder 3061 – Comfort Inner thumb-turn can be operated without transponder; installation length 30-30 mm, stainless steel design | Z4.BO.30-30.CO |
| Digital British Oval Double Thumb-turn Cylinder 3061 – Comfort with G2 functions Inner thumb-turn can be operated without transponder; installation length 30-30 mm, stainless steel design | Z4.BO.30-30.CO.G2 |
| Version with access control, time zone management and events logging | .ZK |
| Weatherproof version, protection rating IP66 (electronic thumb-turn) | .WP |
| 'Network Inside' version with integrated Lock Node | WNM.LN.I |

INSTALLATION LENGTHS (all length specifications: external - inside):

| | |
|---|---------------------|
| Overall length from 65 mm to 80 mm | e.g. Z4.BO.40-40.CO |
| Overall length from 85 mm to 100 mm | e.g. Z4.BO.40-60.CO |
| Overall length over 105 mm up to max. 140 mm (max. 90 mm on one side) | e.g. Z4.BO.65-75.CO |
| Overall length over 140 mm or over 90 mm on one side | on request |

DIGITAL SWISS ROUND DOUBLE THUMB-TURN CYLINDER 3061 – COMFORT

G1

G2

Digital locking cylinder with an enclosed electronics assembly as per DIN EN 15684 / EN 1303 for fitting into doors with a Swiss round profile:

- ⌘ Freely programmable
- ⌘ Active transponder used as medium
- ⌘ Optional access control, events logging and time zone management
- ⌘ Versions with protection rating IP66
- ⌘ Can be directly networked with a retrofit replacement thumb-turn cover

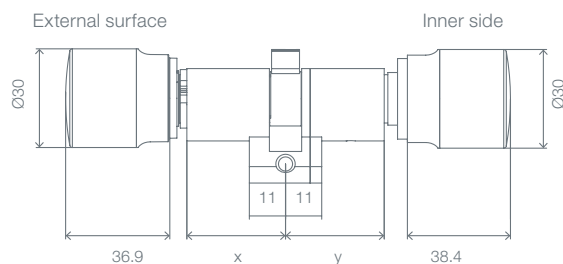
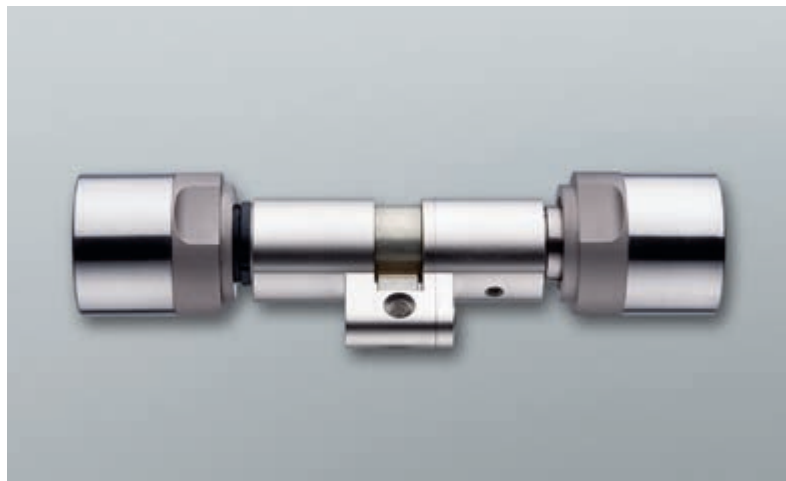

Measurements indicated in mm

TECHNICAL SPECIFICATIONS

- ⌘ Swiss Oval Profile Cylinder Comfort, inner thumb-turn can be operated without transponder
- ⌘ Both thumb-turns can be detached
- ⌘ Thumb-turn diameter: 30 mm
- ⌘ Basic installation length: 30-30 mm (external/inside dimension)
- ⌘ Overall length: up to 140 mm (max. 90 mm on one side); special lengths on request
- ⌘ Protection rating: IP54; .WP version (electronic thumb-turn): IP 66
- ⌘ Battery type: 2 x lithium, CR2450, 3V
- ⌘ Battery life: up to 300,000 lock operations or up to ten years on standby
- ⌘ Temperature range: Operational: -25 °C to +65 °C
In storage: -35 °C to +50 °C
- ⌘ 3,000 access events can be saved
- ⌘ Time zone groups:
 - G1: 5+1
 - G2: 100+1
- ⌘ Number of transponders which can be managed per locking cylinder:
 - G1: up to 8,000
 - G2: up to 64,000
- ⌘ Number of locking devices which can be managed per transponder.
 - G1: up to 48,000
 - G2: up to 304,000
- ⌘ G1: Different permanent/open modes
- ⌘ Can be directly networked with integrated Lock Node (Network Thumb-turn Cover WNM.LN.I) or via external Lock Node with additional door monitoring function
- ⌘ Can be used as a gateway, freely configurable (recommended for small locking systems only)

DIGITAL SWISS ROUND
DOUBLE THUMB-TURN CYLINDER
3061 – COMFORT

PRODUCT VERSIONS

| | |
|--|-------------------|
| Digital Swiss Round Double Thumb-turn Cylinder 3061 – Comfort Inner thumb-turn can be operated without transponder; basic length 30-30 mm, stainless steel design | Z4.SR.30-30.CO |
| Digital Swiss Round Double Thumb-turn Cylinder 3061 – Comfort with G2 functions Inner thumb-turn can be operated without transponder; basic length 30-30 mm, stainless steel design | Z4.SR.30-30.CO.G2 |
| Brass design | .MS |
| Version with access control, time zone management and events logging | .ZK |
| Weatherproof version, protection rating IP66 (electronic thumb-turn) | .WP |
| 'Network Inside' version with integrated Lock Node | WNM.LN.I |

INSTALLATION LENGTHS (all length specifications: external - inside):

| | |
|---|---------------------|
| Overall length from 65 mm to 80 mm | e.g. Z4.SR.40-40.CO |
| Overall length from 85 mm to 100 mm | e.g. Z4.SR.40-60.CO |
| Overall length over 105 mm up to max. 140 mm (max. 90 mm on one side) | e.g. Z4.SR.65-75.CO |
| Overall length over 140 mm or over 90 mm on one side | on request |

DIGITAL SWISS ROUND HALF CYLINDER 3061

G1

G2

Digital half cylinder with an enclosed electronics assembly with Swiss round profile. For special applications, e.g. use on garage doors or in lockers.

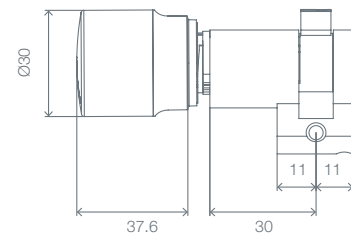

Measurements indicated in mm

TECHNICAL SPECIFICATIONS

- ⚡ Swiss round half cylinder
- ⚡ Thumb-turn detachable
- ⚡ Thumb-turn diameter: 30 mm
- ⚡ Basic installation length: 30-10 mm
- ⚡ Overall length: up to max. 100 mm (outside max. 90 mm); special lengths on request
- ⚡ Protection rating: IP54; .WP version (thumb-turn): IP 66
- ⚡ Battery type: 2 x lithium, CR2450, 3V
- ⚡ Battery life: up to 300,000 lock operations or up to ten years on standby
- ⚡ Temperature range: Operational: -25 °C to +65 °C
In storage: -35 °C to +50 °C
- ⚡ 3,000 access events can be saved
- ⚡ Time zone groups:
 - G1: 5+1
 - G2: 100+1
- ⚡ Number of transponders which can be managed per locking cylinder:
 - G1: up to 8,000
 - G2: up to 64,000
- ⚡ Number of locking devices which can be managed per transponder.
 - G1: up to 48,000
 - G2: up to 304,000
- ⚡ G1: Different permanent/open modes
- ⚡ Can be directly networked with integrated Lock Node (Network Thumb-turn Cover WNM.LN.I) or via external Lock Node with additional door monitoring function
- ⚡ Can be used as a gateway, freely configurable (recommended for small locking systems only)

DIGITAL SWISS ROUND
HALF CYLINDER
3061

PRODUCT VERSIONS

| | |
|---|-------------------|
| Digital Swiss Round Half Cylinder 3061 Installation length 30-10 mm; thumb-turn detachable, stainless steel design | Z4.SR.30-10.HZ |
| Digital Swiss Round Half Cylinder 3061 with G2 functions Installation length 30-10 mm; thumb-turn detachable, stainless steel design | Z4.SR.30-10.HZ.G2 |
| Version with access control, time zone management and events logging | .ZK |
| Multi-point version For use in doors with multi-point locks, from installation length 35-30 mm | .MR |
| Weatherproof version, protection rating IP66 (thumb-turn) | .WP |
| 'Network Inside' version with integrated Lock Node | WNM.LN.I |

INSTALLATION LENGTHS (all length specifications: external - inside):

| | |
|---|---------------------|
| Overall length from 45 mm to 70 mm | e.g. Z4.SR.60-10.HZ |
| Overall length from 75 mm to 100 mm (max. 90 mm on outside) | e.g. Z4.SR.80-10.HZ |
| Overall length over 90 mm on outside | on request |

DIGITAL LOCKING CYLINDER 3061 THUMB-TURNS & ACCESSORIES

Thumb-turn for stiff doors
(Z4.KNAUF2)

Shortened thumb-turn
(Z4.KNAUF4)

Thumb-turn for stiff doors
(Z4.KNAUF3, Z4.KNAUF7, Z4.KNAUF12)

G1

G2



PRODUCT VERSIONS

THUMB-TURNS FOR ACTIVE CYLINDERS

| | |
|---|------------|
| Thumb-turn for non-electronic side in TN3 design, 30 mm in diameter, with handle grips, stainless steel, not suitable for AP/SR cylinders | Z4.KNAUF1 |
| Thumb-turn for non-electronic side on stiff doors, 42 mm in diameter, with handle grips, stainless steel, not suitable for AP/SR cylinders | Z4.KNAUF2 |
| Thumb-turn for electronic side of cylinder, for stiff doors, 35 mm in diameter, made of plastic, suitable for FD/BO.FD only | Z4.KNAUF3 |
| Thumb-turn for non-electronic side of cylinder, trimmed 12 mm to about 21 mm in length, not suitable for AP/SR cylinders | Z4.KNAUF4 |
| Thumb-turn set, matt brass, in a TN4 design, 30 mm in diameter, with handle grips (outside and inside), suitable for FD/BO.FD only | Z4.KNAUF5 |
| Thumb-turn for non-electronic side of the cylinder in TN4 design, diameter 30 mm, with handle grips, stainless steel, not suitable for AP/SR cylinders | Z4.KNAUF6 |
| Thumb-turn for electronic side on stiff doors, 35 mm in diameter, with handle grips, stainless steel, suitable for AP/HZ/SO/SR/BO.CO cylinders | Z4.KNAUF7 |
| Conical thumb-turn set (outside and inside), suitable for FD only | Z4.KNAUF8 |
| Thumb-turn for electronic side in TN4 design, diameter 30 mm, made of plastic | Z4.KNAUF9 |
| Thumb-turn for non-electronic side in AP cylinders in TN4 design, with handle grips, suitable for AP/AP.FD | Z4.KNAUF10 |
| Thumb-turn for electronic side of the cylinder, 35 mm in diameter, V4A stainless steel, high-gloss polished | Z4.KNAUF12 |
| Thumb-turn for non-electronic side of the cylinder in TN4 design, 30 mm in diameter, V4A stainless steel, without logo, for seawater-proof applications | Z4.KNAUF13 |
| Thumb-turn for electronic side of the cylinder, design same as Z4.KNAUF13 | Z4.KNAUF14 |
| TN4 cover for electronic side of the cylinder | Z4.KAPPE1 |
| TN4 cover for electronic side of the cylinder, brass | Z4.KAPPE2 |

DIGITAL LOCKING CYLINDER
3061
THUMB-TURNS & ACCESSORIES

Core protection adapter for VdS/SKG cylinders
(year of manufacture until end of 2010)

Core protection adapter for VdS/SKG cylinders
(year of manufacture 2011 and later)



PRODUCT VERSIONS

ACCESSORIES FOR ACTIVE CYLINDERS

| | |
|--|---------------|
| 20 plastic discs for Half Cylinder Multi-Point .MR for detachable Thumb-turn .DK | Z4.SCHEIBEN |
| Installation/battery key: Special tool for disassembling and for changing batteries (button cells) in TN4 cylinders (double thumb-turn and half cylinders) | Z4.SCHLUESSEL |
| Battery key set for TN3 double thumb-turn and half cylinders | BAT.KEY.SET |
| 10 batteries for TN4 cylinders (double thumb-turn and half cylinders) (type: CR2450) | Z4.BAT.SET |
| Battery set for TN3 cylinders (Double thumb-turn and half cylinders); contains: 5 main batteries (type: 1/2 AA), 5 backup batteries (type: CR1220) | BAT.SET |
| 1 battery for TN1 cylinders (type: 1/2 AA) | 111000 |
| 3 core protection adapters for VdS/SKG cylinders (TN4) manufactured in 2011 and later | Z4.KA.SET2 |
| 3 core protection adapter for VdS/SKG cylinders (TN4) manufactured in 2011 and later, e.g. for special escutcheons up to 16 mm thick | Z4.KA.SET2.IT |
| 3 core protection adapters for VdS/SKG cylinders (TN4) manufactured in 2010 or before and for freely rotating TN4 double thumb-turn cylinder, 8 mm long | Z4.KA.SET |
| 3 core protection adapters for TN3 double thumb-turn cylinders (8, 11 and 14 mm long) | KA.SET |
| 50 grub screws for TN3 cylinders | D-914-3x3 |
| 50 grub screws, M1.5, for TN1 cylinders | 126300 |

INTELLIGENT FASTENING SCREW FOR DOOR MONITORING CYLINDERS

| | |
|--|---------------------|
| Intelligent fastening screw with sensors for use with the Door Monitoring Cylinder. IMPORTANT: you need to indicate the backset to order the intelligent fastening screw. Available in 5 mm increments, from 25 mm to 70 mm 1 unit | Z4.DM. xx.SCREW |
| Intelligent fastening screw with sensors for use with the Door Monitoring Cylinder. IMPORTANT: you need to indicate the backset to order the intelligent fastening screw. Available in 5 mm increments, from 25 mm to 70 mm 5 unit | Z4.DM. xx.SCREW5 |
| Lengths over 70 mm | on request |

CONFIGURATION

DIGITAL LOCKING CYLINDER

G1

G2

COMBINATIONS WITH DIGITAL EURO PROFILE DOUBLE THUMB-TURN CYLINDER 3061

| | MS | ZK | MR | TS | FH | WP | VDS/SKG | WNM |
|-----------|----|----|----|----|----|----|---------|-----|
| FD | ● | ● | ● | ● | ● | ● | ● | ● |
| MS | | ● | ● | ● | ○ | ● | ● | ● |
| ZK | | | ● | ● | ● | ● | ● | ● |
| MR | | | | ● | ● | X | X | ● |
| TS | | | | | ● | X | ● | ● |
| FH | | | | | | ● | ● | ● |
| WP | | | | | | | ● | ● |
| VDS / SKG | | | | | | | | ● |

COMBINATIONS WITH DIGITAL EURO PROFILE DOUBLE THUMB-TURN CYLINDER 3061 – ANTI-PANIC

| | FD | CO | MS | TS | FH | ZK | WP | VDS | OK | WNM |
|-----|----|----|----|----|----|----|----|-----|----|-----|
| AP | X | ● | ● | X | X | ● | ● | X | ● | ● |
| AP2 | ● | X | ● | ● | ● | ● | ● | ● | ● | ● |
| FD | | X | ● | ● | ● | ● | ● | ● | X | ● |
| CO | | | ● | X | X | ● | ● | X | X | ● |
| MS | | | | ● | ○ | ● | ● | ● | ● | ● |
| TS* | | | | | ● | ● | X | ● | ● | ● |
| FH | | | | | | ● | ● | ● | ● | ● |
| ZK | | | | | | | ● | ● | ● | ● |
| WP | | | | | | | | ● | ● | ● |
| VDS | | | | | | | | | ● | ● |
| OK | | | | | | | | | | ● |

CONFIGURATION DIGITAL LOCKING CYLINDER

COMBINATIONS WITH DIGITAL EURO PROFILE DOUBLE THUMB-TURN CYLINDER 3061 – COMFORT

| | MS | ZK | WP | SW | WNM |
|----|----|----|----|----|-----|
| CO | ● | ● | ● | ● | ● |
| MS | | ● | ● | X | ● |
| ZK | | | ● | ● | ● |
| WP | | | | ● | ● |
| SW | | | | | ● |

KEY:

| | |
|---------|---|
| AP/ AP2 | Anti-panic |
| BL | Reader on both sides |
| BO | British oval |
| DK | Detachable thumb-turn |
| FD | Freely rotating |
| FH | Fire-retardant version |
| HZ | Half cylinder |
| MP | SC cylinder |
| MR | Multi-point version |
| MS | Brass design |
| OK | Without inside thumb-turn |
| RS | Scandinavian round |
| SKG | VdS Approval Class AZ, SKG Approval SKG*** |
| SO | Scandinavian oval |
| SR | Swiss round |
| SW | Seawater-proof version |
| TS | Button control |
| VDS | VdS design |
| VR | Shortened range |
| WNM | Network Inside – network-ready online |
| WP | Weatherproof version |
| ZK | Access control, time zone man- agement and events logging. |

COMBINATIONS WITH DIGITAL EURO PROFILE DOUBLE THUMB-TURN CYLINDER 3061 – DOOR MONITORING

| | MS | ZK | TS | FH | WP | WNM |
|-------|----|----|----|----|----|-----|
| DM FD | X | ● | ○ | ● | ● | ● |
| MS | | ● | ● | ○ | ● | ● |
| ZK | | | ● | ● | ● | ● |
| TS | | | | ● | X | ● |
| FH | | | | | ● | ● |
| WP | | | | | | ● |
| VDS | | | | | | ● |

CONFIGURATION
DIGITAL LOCKING CYLINDER

COMBINATIONS WITH DIGITAL EURO PROFILE
HALF CYLINDER 3061

| | MS | ZK | MR | WP | DK | VR | WNM |
|----|----|----|----|----|----|----|-----|
| HZ | ○ | ● | ● | ● | ● | ● | ● |
| MS | | ○ | ○ | ○ | ○ | ○ | ○ |
| ZK | | | ● | ● | ● | ● | ● |
| MR | | | | ● | ● | ● | ● |
| WP | | | | | ● | ○ | ● |
| DK | | | | | | ● | ● |
| VR | | | | | | | ● |

COMBINATIONS WITH DIGITAL EURO PROFILE
HALF CYLINDER 3061 – DOOR MONITORING

| | MS | ZK | WP | DK | VR | WNM |
|-------|----|----|----|----|----|-----|
| HZ DM | ○ | ● | ● | ● | ● | ● |
| MS | | ○ | ○ | ○ | ○ | ○ |
| ZK | | | ● | ● | ● | ● |
| WP | | | | ● | ○ | ● |
| DK | | | | | ● | ● |
| VR | | | | | | ● |

COMBINATIONS WITH DIGITAL SCANDINAVIAN
OVAL CYLINDER 3061
ROUND CYLINDER 3061

| | SO | RS | MS | ZK | WP | SW | WNM |
|------------------------|----|----|----|----|----|----|-----|
| SO (Scandinavian Oval) | | X | ○ | ● | ● | ● | ● |
| RS (Round) | | | ○ | ● | ● | ● | ● |
| MS | | | | ○ | ○ | ○ | ○ |
| ZK | | | | | ● | ● | ● |
| WP | | | | | | ● | ● |
| SW | | | | | | | ● |

CONFIGURATION
DIGITAL LOCKING CYLINDER

COMBINATIONS WITH DIGITAL BRITISH OVAL
DOUBLE THUMB-TURN CYLINDER 3061

| | MS | ZK | TS | FH | WP | WNM |
|-------|----|----|----|----|----|-----|
| BO FD | ○ | ● | ● | ● | ● | ● |
| MS | | ○ | ○ | ○ | ○ | ○ |
| ZK | | | ● | ● | ● | ● |
| TS | | | | ● | X | ● |
| FH | | | | | ● | ● |
| WP | | | | | | ● |

COMBINATIONS WITH DIGITAL BRITISH OVAL
DOUBLE THUMB-TURN CYLINDER 3061 –
COMFORT

| | MS | ZK | WP | WNM |
|-------|----|----|----|-----|
| BO CO | ○ | ● | ● | ● |
| MS | | ○ | ○ | ○ |
| ZK | | | ● | ● |
| WP | | | | ● |

COMBINATIONS WITH DIGITAL SWISS ROUND
CYLINDER 3061 – COMFORT

| | MS | ZK | WP | WNM |
|-------|----|----|----|-----|
| SR.CO | ○ | ● | ● | ● |
| MS | | ○ | ○ | ○ |
| ZK | | | ● | ● |
| WP | | | | ● |

COMBINATIONS WITH DIGITAL SWISS ROUND
HALF CYLINDER 3061

| | MS | ZK | WP | WNM |
|-------|----|----|----|-----|
| SR.HZ | ○ | ● | ● | ● |
| MS | | ○ | ○ | ○ |
| ZK | | | ● | ● |
| WP | | | | ● |

ACTIVE TECHNOLOGY

DIGITAL SMART HANDLES

3062



DIGITAL SMART HANDLE 3062

COMPOSITION OF ITEM CODE WITH EXAMPLE:

Identifier for electronic door handle = SH

Profile: **A = Euro Profile/Swiss Round/British Oval**

B = Scandinavian Oval

C = Euro Profile with Mechanical Override (MO)

D = Swiss Round with MO

E = Scandinavian Oval with MO

Profile/door thickness: **S = 39-60 mm or 33-54 mm for SO, 30-51 for SO.DP** (an additional adapter is required for British Oval)

M = 59-80 mm or 53-74 mm for SO, 50-71 mm for SO.DP

L = 79-100 mm or 73-94 mm for SO, 70-91 mm for SO.DP

Spindle: 07 = 7 mm

08 = 8 mm

F8 = 8 mm (fire retardant doors)

F8 = 9 mm (fire retardant doors)

10 = 10 mm (with adapter sleeve)

8.5 mm (through sleeve SH.HUELSE.8.5; see under Accessories)

Fastening type / plate width: A = snap-in, narrow (41 mm)

B = snap-in, wide (53 mm)

C = conventional fastening, narrow (41 mm)

D = conventional fastening, wide (53 mm)

E = conventional fastening MO – inside and outside cut-out, narrow (41 mm)

F = conventional fastening MO – inside and outside cut-out – wide (53 mm)

G = conventional fastening MO – inside blank/outside cut-out, narrow (41 mm)

H = conventional fastening MO – inside blank/outside cut-out, wide (53 mm)

I = conventional fastening MO – inside cut-out/outside blank, narrow (41 mm)

J = conventional fastening MO – inside cut-out/outside blank, wide (53 mm)

K = conventional fastening MO – inside and outside blank, narrow (41 mm)

L = conventional fastening MO – inside and outside blank, wide (53 mm)

Centres distance: 00 = conventional fastening system

70 = 70 mm

72 = 72 mm

74 = 74 mm (for Swiss Round only)

75 = 75 mm

78 = 78 mm

85 = 85 mm

88 = 88 mm

90 = 90 mm

92 = 92 mm

94 = 94 mm (for Swiss Round only)

96 = 96 mm (for Scandinavian Oval only)

05 = 105 mm (for Scandinavian Oval only)

Version: 0 = engaged for use (without electronics, not for Scandinavian Oval)

1 = engaged for use on one side

Handle versions, outside: **A = L-shaped R (rounded)**

B = L-shaped G (mitred)

C = U-shaped R (rounded)

D = U-shaped G (mitred)

E = U-shaped R (rounded, curved), offset

F = U-shaped G (mitred), offset

Handle versions inside: **A = L-shaped R (rounded)**

B = L-shaped G (mitred)

C = U-shaped R (rounded, curved)

D = U-shaped G (mitred)

E = U-shaped R (rounded, curved), offset

F = U-shaped G (mitred), offset

Surface finish: **1 = brushed stainless steel**

3 = brass

Reader technology: 0 = without electronics

1 = active

2 = hybrid

3 = MIFARE® Pure

Options: **G2, ZK, WP, DP** (for SO only)

SH AS 10 B 85 1 A A 1 1 G2

Item code for the aforementioned example: SHAS10B851AA11G2

DIGITAL SMART HANDLE 3062

G1

G2

This SimonsVoss electronic door handle combines intelligent access control functions with an elegant, ergonomic design. Behind its slim, flat exterior lies highly innovative technology.

In developing the new SmartHandle 3062 door fitting, we focussed particularly on usage requirements in the healthcare and care home sectors. In addition to active technology, Smart Handle is also available in a Smart Card version and can be used with doors fitted with Euro Profile cylinder, Swiss Round, British Oval and Scandinavian Oval mortise locks.

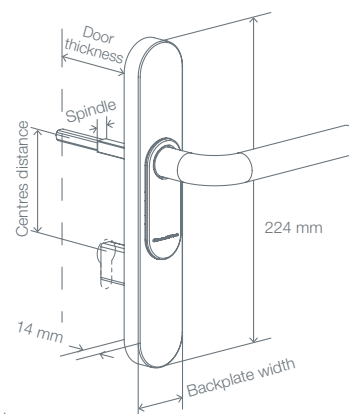

Measurements indicated in mm

UNIQUE SELLING POINT

The innovative snap-in fitting system means that there is no need to drill holes in doors, thus ensuring existing doors are not damaged and installation times are greatly reduced.

SYSTEM SPECIFICATIONS AND INTERDEPENDENCIES WITH OTHER PRODUCTS

LSM 3.1 or higher, Programming Device Smart CD.G2.

TECHNICAL SPECIFICATIONS

- ⚡ Types: Euro Profile cylinder (as per DIN 18252 / EN1303), British Oval, Swiss Round, Scandinavian Oval
- ⚡ Dimensions (W x H x D):
Narrow: 41 x 224 x 14 mm
Wide: 53 x 224 x 14 mm
- ⚡ Dimensions SO (W x H x D):
Narrow: 48 x 230.2 x 21.75 mm
Wide: 59 x 229.2 x 21.75 mm
- ⚡ Dimensions SO DP (W x H x D):
Narrow: 48 x 230.2 x 24.75 mm
Wide: 59 x 229.2 x 24.75 mm
- ⚡ Reader type: SV active
- ⚡ Battery type: 2x CR2450, 3 V, lithium.
- ⚡ Battery life: up to 150,000 operations or up to 10 years on stand-by

- ⚡ Temperature range: operational: -20°C to +50°C
- ⚡ In storage (temporary): -40°C to +70°C
In storage (long-term): 0°C to +30°C
- ⚡ Feedback signal: audible (buzzer)
- ⚡ Storable access events: up to 3,000
- ⚡ Time zone groups:
G1: 5+1
G2: 100+1
- ⚡ Number of transponders which can be managed per cylinder:
G1: up to 8,000
G2: up to 64,000
- ⚡ Number of locking operations which can be managed per transponder:
G1: up to 48,000
G2: up to 304,000
- ⚡ Different permanent/open modes
- ⚡ Networking capability: network-ready with integrated LockNode (can be retrofit at any time)
- ⚡ Upgradability: firmware upgradable
- ⚡ Miscellaneous: can be used as gateway (recommended for smaller locking systems only), freely configurable

DIGITAL SMART HANDLE 3062

Digital SmartHandle is available with three different types of fastening:
Snap-in, conventional fastening or conventional fastening with mechanical override (MO).

BASIC VERSIONS

| Description | Order code |
|--|--|
| DIGITAL SMART HANDLE 3062 | |
| Digital SmartHandle 3062 – Snap-in Electronic door handle for mounting on doors, equipped with a handle lock for Euro Profile, Swiss Round or British Oval; outer side can only be operated with a SimonsVoss transponder; inside is always engaged ready for use. | SHA*...A**1*** SHA*...B**1*** |
| Digital SmartHandle 3062 – Conventional Fastening Electronic door handle for conventional fitting to doors with screws; equipped with a handle lock for Euro Profile, Swiss Round or British Oval; outer side can only be operated with a SimonsVoss transponder; inside is always engaged ready for use. | SHA*...C**1*** SHA*...D**1*** |
| Digital SmartHandle 3062 – Conventional Fastening MO – for Euro Profile Electronic door handle for conventional fitting to doors with screws; additional options for installing a mechanical cylinder as a secondary lock; equipped with a handle lock for Euro Profile; outer side can only be operated with a SimonsVoss transponder; inside is always engaged ready for use. | SHC*...E-L**1*** |
| Digital SmartHandle 3062 – Conventional Fastening with MO – for Swiss Round Electronic door handle for conventional fitting to doors with screws; additional options for installing a mechanical cylinder as a secondary lock; equipped with a handle lock for Swiss Round; outer side can only be operated with a SimonsVoss transponder; inside is always engaged ready for use. | SHD*...E-L**1*** |
| Digital SmartHandle 3062 – Snap-in with G2 Functions Electronic door handle for mounting on doors, equipped with a handle lock for Euro Profile, Swiss Round or British Oval; outer side can only be operated with a SimonsVoss transponder; inside is always engaged ready for use. | SHA*...A**1G2*** SHA*...B**1G2*** |
| Digital SmartHandle 3062 – Conventional Fastening with G2 Functions Electronic door handle for mounting on doors, equipped with a handle lock for Euro Profile, Swiss Round or British Oval; outer side can only be operated with a SimonsVoss transponder; inside is always engaged ready for use. | SHA*...C**1G2*** SHA*...D**1G2*** |
| Digital SmartHandle 3062 – Conventional Fastening with MO and G2 Functions – for Euro Profile Electronic door handle for conventional fitting to doors with screws; additional options for installing a mechanical cylinder as a secondary lock; equipped with a handle lock for Euro Profile; outer side can only be operated with a SimonsVoss transponder; inside is always engaged ready for use. | SHC*...E-L**1G2*** |
| Digital SmartHandle 3062 – Conventional Fastening with MO and G2 Functions – for Swiss Round Electronic door handle for conventional fitting to doors with screws; additional options for installing a mechanical cylinder as a secondary lock; equipped with a handle lock for Swiss Round; outer side can only be operated with a SimonsVoss transponder; inside is always engaged ready for use. | SHD*...E-L**1G2*** |
| Digital SmartHandle 3062 – without electronics | On request |

* Identifiers for profile:

A = Euro Profile/Swiss Round/British Oval
C = Euro Profile with mechanical override
D = Swiss Round with mechanical override

** Identifiers for fastening system/backplate width:

A = snap-in, narrow
B = snap-in, wide
C = conventional fastening, narrow
D = conventional fastening, wide
E-L = versions for mechanical override

*** Identifiers for reader technology/option:

1 = active
G2 = with G2 functions

DIGITAL
SMART HANDLE 3062

OPTIONS

| Description | Order code |
|--|------------|
| PROFILE | |
| Euro Profile / Swiss Round / British Oval* | A |
| Euro Profile with mechanical override (MO) | C |
| Swiss Round with mechanical override (MO) | D |
| DOOR THICKNESS | |
| 39 – 60 mm | S |
| 59 – 80 mm | M |
| 79 – 100 mm | L |
| SPINDLE | |
| 7 mm | 07 |
| 8 mm | 08 |
| 8 mm (fire retardant doors) | F8 |
| 9 mm (fire retardant doors) | 09 |
| 10 mm (with adapter sleeve) | 10 |
| FASTENING SYSTEM/PLATE WIDTH | |
| Snap-in plate (41 mm) | A |
| Snap-in plate (53 mm) | B |
| Conventional fastening, narrow (41 mm) | C |
| Conventional fastening, wide (53 mm) | D |
| MO cut-out inside and outside, narrow (41 mm) | E |
| MO inside and outside cut-out, wide (53 mm) | F |
| MO inside blank, cut-out outside, narrow (41 mm) | G |
| MO inside blank, cut-out outside, wide (53 mm) | H |
| MO inside cut-out, outside blank, narrow (41 mm) | I |
| MO inside cut-out, outside blank, wide (53 mm) | J |
| MO inside and outside blank, narrow (41 mm) | K |
| MO inside and outside blank, wide (53 mm) | L |

*Adapter sleeve required (see Accessories)

DIGITAL
SMART HANDLE 3062

| Description | Order code |
|--|------------|
| CENTRES DISTANCE | |
| Conventional fastening | 00 |
| 70 mm (for snap-in only) | 70 |
| 72 mm (for Snap-in and Mechanical Override only) | 72 |
| 74 mm (for Swiss Round – Snap-in and Mechanical Override only) | 74 |
| 75 mm (for Snap-in and Mechanical Override only) | 75 |
| 78 mm (for Snap-in and Mechanical Override only) | 78 |
| 85 mm (for Snap-in and Mechanical Override only) | 85 |
| 88 mm (for Snap-in and Mechanical Override only) | 88 |
| 92 mm (for Snap-in and Mechanical Override only) | 92 |
| 94 mm (for Swiss Round – Snap-in and Mechanical Override only) | 94 |
| VERSION | |
| Engaged (for SmartHandles without electronics only) | 0 |
| Coupling on one side (for all SmartHandles with electronics) | 1 |
| HANDLE VERSION, OUTSIDE | |
| L-shaped R (rounded) | A |
| L-shaped G (mitred) | B |
| U-shaped R (rounded) | C |
| U-shaped G (mitred) | D |
| U-shaped R (rounded), offset | E |
| U-shaped G (mitred), offset | F |
| HANDLE VERSION, INSIDE | |
| L-shaped R (rounded) | A |
| L-shaped G (mitred) | B |
| U-shaped R (rounded) | C |
| U-shaped G (mitred) | D |
| U-shaped R (rounded), offset | E |
| U-shaped G (mitred), offset | F |

DIGITAL
SMART HANDLE 3062

| Description | Order code |
|--|---------------|
| SURFACE | |
| Stainless steel, brushed | 1 |
| Brass version | 3 |
| READER TECHNOLOGY | |
| No electronics | 0 |
| Active | 1 |
| OPTIONS | |
| With G2 functions | G2 |
| Version with access control, time zone control and logging | ZK |
| Weatherproof version | WP |
| ADAPTER | |
| Adapter for a handle lock designed to hold a British Oval profile | SH.BO.ADAPT |
| SPINDLE | |
| Sleeve from 8 to 8.5 mm (10 units) | SH.HUELSE.8.5 |
| Sleeve from 7 to 8 mm (10 units) | SH.HUELSE.7.8 |
| DIRECT NETWORKING FOR DIGITAL SMART HANDLE | |
| LockNode for integration into electronic door handles; to directly network SmartHandle 3062 (can be retrofitted) | WNM.LN.I.SH |
| Weatherproof version of the LockNode for outdoor use; can only be ordered together with the weatherproof version of the SmartHandle (WP) | WP |
| COVER FOR RETROFIT OR REPLACEMENT | |
| Cover (narrow) and inlay for retrofit or as replacement | SH.CS |
| Cover (narrow) and inlay for retrofit or as a replacement; indicate the centres distance for the cut-out (e.g. 72 mm) | SH.CB.xx |
| Cover (wide) and inlay for retrofit or as replacement | SH.CB |
| Cover (wide) and inlay for retrofit or as a replacement; indicate the centres distance for the cut-out (e.g. 72 mm) | SH.CB.xx |
| DIRECT NETWORKING FOR DIGITAL SMART HANDLE | |
| You can find our order placement guide SmartHandle in the retailer section on our website a www.simons-voss.com . | |

DIGITAL SMART HANDLE 3062 – SCANDINAVIAN OVAL

G1 G2



BASIC VERSIONS

| Description | Order code |
|--|-----------------|
| DIGITAL SMART HANDLE 3062 – SCANDINAVIAN OVAL | |
| Digital SmartHandle 3062 Electronic door handle for mounting on doors, with handle lock designed for Scandinavian Oval; outer side can only be operated with SimonsVoss transponder; inner side is permanently engaged ready for use. | SHB*1** |
| Digital SmartHandle 3062 – MO Electronic door handle for mounting on doors; additional options for installing a mechanical cylinder as a secondary lock; with handle lock designed for Scandinavian Oval; outer side can only be operated with SimonsVoss transponder; inner side is permanently engaged ready for use. | SHE*1** |
| Digital SmartHandle 3062 with G2 Functions Electronic door handle for mounting on doors, with handle lock designed for Scandinavian Oval; outer side can only be operated with SimonsVoss transponder; inner side is permanently engaged ready for use. | SHB*1G2** |
| Digital SmartHandle 3062 with MO and G2 Functions Electronic door handle for mounting on doors; additional options for installing a mechanical cylinder as a secondary lock; with handle lock designed for Scandinavian Oval; outer side can only be operated with SimonsVoss transponder; inner side is permanently engaged ready for use. | SHE*1G2** |
| Digital SmartHandle 3062 – without electronics | On request |

OPTIONS

| Description | Order code |
|--|------------|
| PROFILE | |
| Scandinavian Oval | B |
| Scandinavian Oval with Mechanical Override (MO) | E |
| DOOR THICKNESS SO | |
| 33 – 54 mm | S |
| 53 – 74 mm | M |
| 73 – 94 mm | L |
| DOOR THICKNESS SO DP | |
| 30 – 51 mm (for versions with drilling protection DP only) | S |
| 50 – 71 mm (for versions with drilling protection DP only) | M |
| 70 – 91 mm (for versions with drilling protection DP only) | L |

* Identifiers for profile:

B = Scandinavian Oval

E = Scandinavian Oval with Mechanical Override

*** Identifier for reader technology/option:

1 = active

G2 = with G2 functions

DIGITAL
SMART HANDLE 3062 –
SCANDINAVIAN OVAL

| Description | Order code |
|---|------------|
| SPINDLE | |
| 7 mm | 07 |
| 8 mm | 08 |
| 8 mm (fire retardant doors) | F8 |
| 9 mm (fire retardant doors) | 09 |
| 10 mm (with adapter sleeve) | 10 |
| FASTENING SYSTEM/PLATE WIDTH | |
| Conventional fastening, narrow (41 mm) | C |
| Conventional fastening, wide (53 mm) | D |
| MO cut-out inside and outside, narrow (41 mm) | E |
| MO inside and outside cut-out, wide (53 mm) | F |
| MO inside blank, cut-out outside, narrow (41 mm) | G |
| MO inside blank, cut-out outside, wide (53 mm) | H |
| MO inside cut-out, outside blank, narrow (41 mm) | I |
| MO inside cut-out, outside blank, wide (53 mm) | J |
| MO inside and outside blank, narrow (41 mm) | K |
| MO inside and outside blank, wide (53 mm) | L |
| CENTRES DISTANCE | |
| Adapter fastening | 00 |
| 96 mm (not for Mechanical Override) | 96 |
| 105 mm (for Mechanical Override only) | 05 |
| VERSION | |
| Engaged (for SmartHandle without electronics only) | 0 |
| Engages for use on one side (for all SmartHandles with electronics) | 1 |

DIGITAL
SMART HANDLE 3062 –
SCANDINAVIAN OVAL

| Description | Order code |
|--|-------------|
| HANDLE VERSION, OUTSIDE | |
| L-shaped R (rounded) | A |
| L-shaped G (mitred) | B |
| U-shaped R (rounded) | C |
| U-shaped G (mitred) | D |
| U-shaped R (rounded), offset | E |
| U-shaped G (mitred), offset | F |
| HANDLE VERSION, INSIDE | |
| L-shaped R (rounded) | A |
| L-shaped G (mitred) | B |
| U-shaped R (rounded) | C |
| U-shaped G (mitred) | D |
| U-shaped R (rounded), offset | E |
| U-shaped G (mitred), offset | F |
| SURFACE | |
| Stainless steel, brushed | 1 |
| Brass version | 3 |
| READER TECHNOLOGY | |
| No electronics | 0 |
| Active | 1 |
| OPTIONS | |
| With G2 functions | G2 |
| Version with access control, time zone control and logging | ZK |
| Weatherproof version | WP |
| Drilling Protection | DP |
| DIRECT NETWORKING FOR DIGITAL SMART HANDLE | |
| LockNode for integration into electronic door handles; to directly network SmartHandle 3062 (can be retrofitted) | WNM.LN.I.SH |
| Weatherproof version of the LockNode for outdoor use; can only be ordered together with the weatherproof version of the SmartHandle (WP) | WP |
| DIRECT NETWORKING FOR DIGITAL SMART HANDLE | |

You can find our order placement guide SmartHandle in the retailer section on our website www.simons-voss.com.

ACTIVE TECHNOLOGY

DIGITAL SMART RELAY

3063



Simons  Voss

DIGITAL SMART RELAY 3063

G1

G2

Digital Smart Relay 3063 can serve as an access control reader or key switch. In System 3060, it opens electrically operated doors, gates and barriers, and switches lighting, heating and machines on and off. It transfers transponder data to external systems, such as time-and-attendance systems, cashless vending systems or facility management.

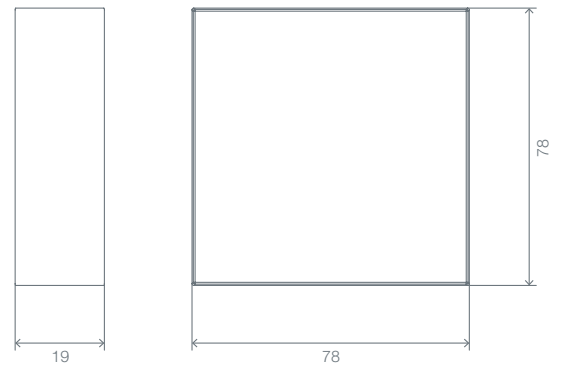

Measurements indicated in mm

TECHNICAL SPECIFICATIONS

- ⚡ Housing made of white plastic (polyamide 6.6)
Dimensions: 78 x 78 x 19 mm (H x W x D)
- ⚡ Housing made of black plastic (polyamide 6.6)
Dimensions: 55.4 x 71.8 x 25.1 mm (H x W x D)
- ⚡ Protection rating: IP20; not suitable for unprotected use outdoors
- ⚡ Typical reading range: up to 120 cm
- ⚡ Temperature range: Operational: -22 °C to +55 °C
- ⚡ Humidity: < 95 % without condensation
- ⚡ Circuit board dimensions: 50 x 50 x 14 mm (H x W x D)
- ⚡ Lock Node can be integrated into the Smart Relay housing for direct networking of Smart Relay-G2
- ⚡ Power supply voltage: 12 V AC (for SREL only) or 5–24 V DC (no polarity protection)
- ⚡ Power limitation Mains adapter must be limited to 15 V A
- ⚡ Standby current: < 5 mA
- ⚡ Max. current: < 100 mA
- ⚡ Pulse duration can be programmed between 0.1 and 25.5 sec.
- ⚡ Optional battery operation possible (for G1 and black housing only)
- ⚡ Winner of the Red Dot Design Award 2010

TECHNICAL SPECIFICATIONS FOR OUTPUT RELAY

- ⚡ Type: changeover contact; in SREL2: normally open contact (reversible)
- ⚡ Continuous current: max. 1.0 A
- ⚡ Switch-on current: max. 2.0 A
- ⚡ Switching voltage: max. 24 V
- ⚡ Switching power: 10⁶ activations at 24 V A
- ⚡ Multi-function connections F1, F2, F3: max. 24 V DC, max. 50 mA
- ⚡ Vibrations: 15 G for 11 ms, 6 shocks in accordance with IEC 68-2-27; not approved for permanent operation under vibrations

DIGITAL SMART RELAY 3063

Version with housing made from black plastic

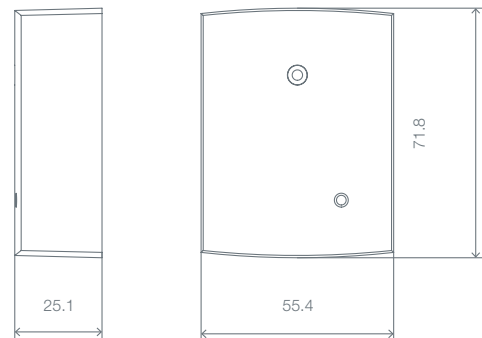

Measurements indicated in mm

PRODUCT VERSIONS

| | |
|--|------------------|
| Digital Smart Relay 3063 in black housing Basic version with integrated antenna, flip-flop function, repeater function, including backup battery | SREL |
| Digital Smart Relay 3063 in black housing, as basic version, but with G2 functions and connection for external antenna (SREL.AV) | SREL.G2 |
| Digital Smart Relay 3063 in black housing, as basic version, but with access control, time zone control and event logging. | SREL.ZK |
| Digital Smart Relay 3063 in black housing, as basic version, but with access control, time zone control, event logging, G2 functions and connection for external antenna (SREL.AV) | SREL.ZK.G2 |
| Version in white design housing, for surface mount; can be used together with WNM.LN.I.SREL.G2 (so no connection for external antenna SREL.AV). | .W |
| Smart Relay Advanced (for G1 lock systems only) Version with integrated antenna, access control and time zone control, serial ports, bus-capable For connecting external modules, connection for external antenna (SREL.AV), connection for external LED/buzzer, flip-flop function, repeater function, including backup battery | SREL.ADV |
| External antenna for connecting Smart Relay Advanced versions and all G2 versions (cable 5 m long) | SREL.AV |
| Battery for Smart Relay in black housing, G1 or G2, (not for Gateway applications or together with direct networking) for operation without external power supply, including soldered connector cable, including plug connector to Smart Relay, lithium 1/2 AA battery | SREL.BAT |
| Lock Node which can be integrated into the white Smart Relay housing (for version *.W only) to directly network Smart Relay with auto-configuration (can be retrofitted) | WNM.LN.I.SREL.G2 |

DIGITAL SMART OUTPUT MODULE

G1

The Smart Output Module has eight isolated relay outputs and is connected to Smart Relay Advanced. It can be used to perform tasks such as directing a lift to different floors in a building.

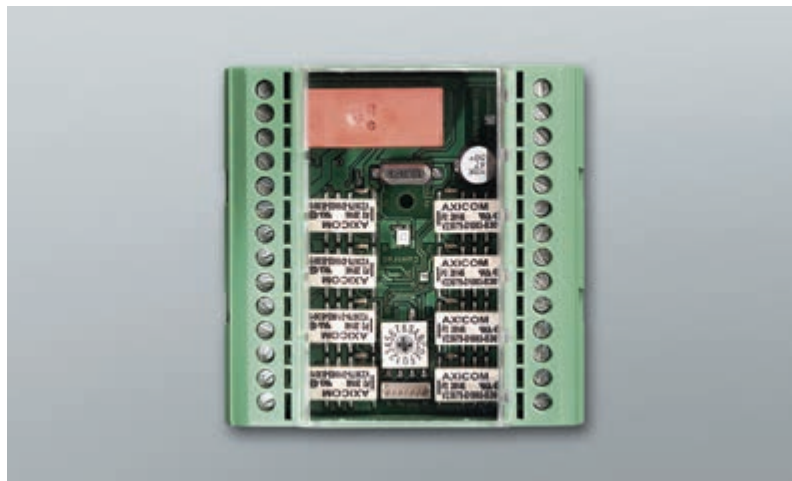

TECHNICAL SPECIFICATIONS

- ⌘ Housing made of green plastic (polycarbonate)
- ⌘ Dimensions: 75 x 75 x 53 mm (H x W x D)
- ⌘ Protection rating: IP20; not suitable for unprotected use outdoors
- ⌘ Temperature range: Operational: 0 °C to +60 °C
In storage: 0 °C to +70 °C
- ⌘ Humidity: < 90 % without condensation
- ⌘ Power supply voltage: 11 to 15 V DC; recommended: 12 V DC, regulated
- ⌘ Power limitation: Mains adapter must be limited to 15 V A
- ⌘ Standby current: < 120 mA
- ⌘ Max. current: < 150 mA
- ⌘ Pulse duration can be programmed between 0.1 and 25.5 sec.
- ⌘ Output relay type: normally closed
- ⌘ Output relay and AUX relay permanent current: max. 1.0 A
- ⌘ Output relay and AUX relay starting current: max. 2.0 A
- ⌘ Output relay and AUX relay switching voltage: max. 24 V
- ⌘ Output relay switching performance: 10⁶ activations at 24 V A
- ⌘ Vibrations: 15 G for 11 ms, 6 shocks in accordance with IEC 68-2-27
- ⌘ Output 1 switching current: max. 1 A
- ⌘ Output 1 switching voltage: max. 24 V
- ⌘ Output 1 switching performance: max. 24 VA
- ⌘ Output 1 switching behaviour when voltage below target:
U_v < 10.5 +/- 0.5 V
- ⌘ Each Smart Relay Advanced can actuate up to 16 modules for a max. of 128 floors

PRODUCT VERSIONS

Smart Output Module
Additional module for the Smart Relay Advanced
with 8 relay outputs that can be switched using a
transponder

MOD.SOM8

DIGITAL SMART RELAY 2 3063

G2

Digital Smart Relay 2 3063 is an electronic switch which can be activated with a SimonsVoss ID medium. Smart Relay thus performs the function of an access control reader or a key switch.

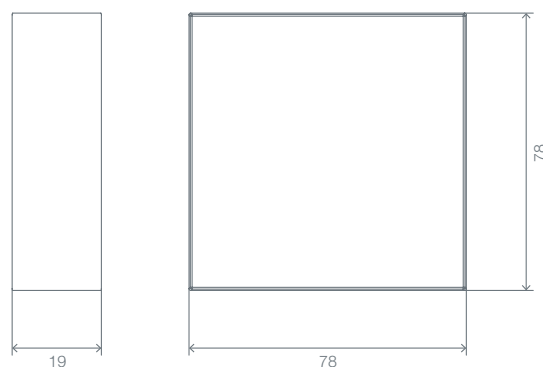

Measurements indicated in mm

- Instantly wireless network-ready

CUSTOMER BENEFIT

- Intelligent additional component for locking devices
- It can be used as a gateway in a virtual network

SYSTEM SPECIFICATIONS AND INTERDEPENDENCIES WITH OTHER PRODUCTS

LSM

- LSM 3.1 SP1 and higher

Network

- Virtual network and online
- You need to order the ZK version to use the product as a gateway in a virtual network

Miscellaneous

- Must be integrated into a G2 or mixed locking system.

TECHNICAL SPECIFICATIONS

- Housing made of white plastic (polyamide 6.6)
Dimensions: 78 x 78 x 19 mm (H x W x D)
Semi-transparent base plate
- Protection rating: IP 20,
IP54 as WP variant
(IP65 with additional seal for the cable inlet)
- Humidity: < 95 % without condensation
- Vibrations: 15 G for 11 ms,
6 shocks as per IEC 68-2-27
Not approved for use when subject to permanent vibrations
- Circuit board dimensions: 50 x 50 x 14 mm (H x W x D)
- Power supply voltage: 9-24 V DC
- Power limitation: mains adapter must be limited to 15 V A
- Standby current: < 100 mA
- Max. current: < 300 mA
- Pulse duration can be programmed between 1 and 25.5 sec.

DIGITAL
SMART RELAY 2
3063

TECHNICAL SPECIFICATIONS FOR OUTPUT RELAY

- ⚡ Type: NO contact
Normally open contact reversible
- ⚡ Permanent current: max. 1.0 A
- ⚡ Switch-on current: max. 2.0 A
- ⚡ Switching voltage: max. 24 V
- ⚡ Switching power: 10⁶ activations at 30 V A
- ⚡ Multi-function connections F1, F2, F3: max. 24 V DC, max. 50 mA
- ⚡ Loggable access events: 3,600 access events
200 access events as gateway
- ⚡ Time zone groups: 100+1
- ⚡ Number of transponders that can be managed per locking cylinder: up to 64,000
- ⚡ Networking capability: network-ready with integrated Lock Node (WNM.LN.I.SREL2.G2) or via external Lock Node with added door monitoring function
- ⚡ Other: Can be used as gateway, freely configurable

PRODUCT VERSIONS

| | |
|--|------------------|
| Digital Smart Relay 2 3063: Basic version in white housing, relay contact as NO contact (reversible to break contact); can only be operated with direct current (9 to 24 V DC); can be directly networked with integrated Lock Node (must be ordered separately), with connection available for an external antenna (SREL.AV) | SREL2.G2.W |
| As Smart Relay 2 basic version, but with access control, time zone control and event logging; can be used as a gateway for virtual transponder networking (active) in a WaveNet network | SREL2.ZK.G2.W |
| Digital Smart Relay 2 for transponders As Smart Relay 2 Basic Version, but with access control, time zone control and events logging. With serial port and the option of triggering the SREL2 by means of an external circuit (isolated NO contact). Can be used as gateway in a virtual network (active transponder). Designed to also house an internal MIFARE® card reader and able to connect one or two additional external MIFARE card readers. | SREL2.ZK.MH.G2.W |

ACTIVE TECHNOLOGY
VDS BLOCK LOCK

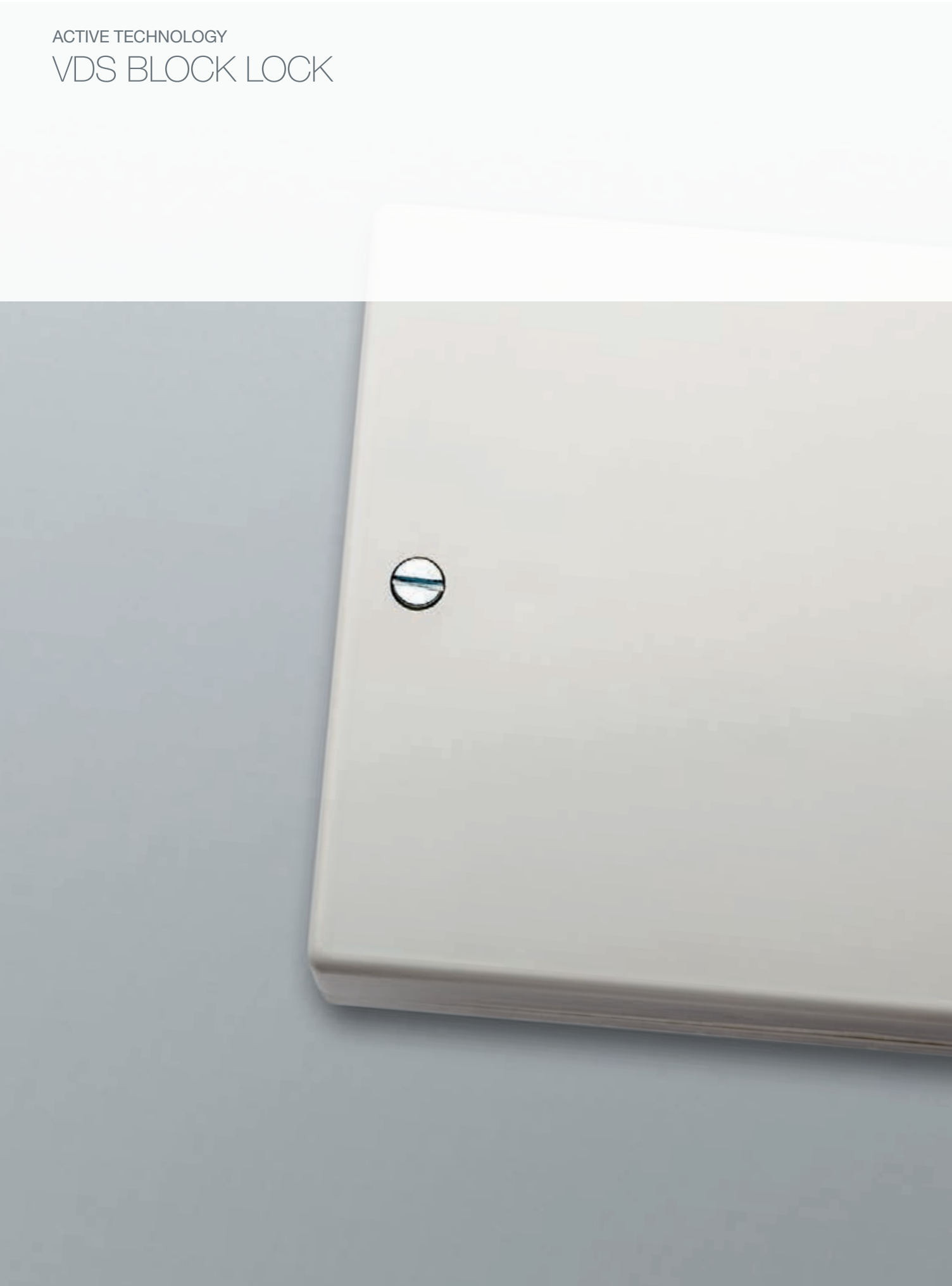

MODE OF OPERATION VDS BLOCK LOCK

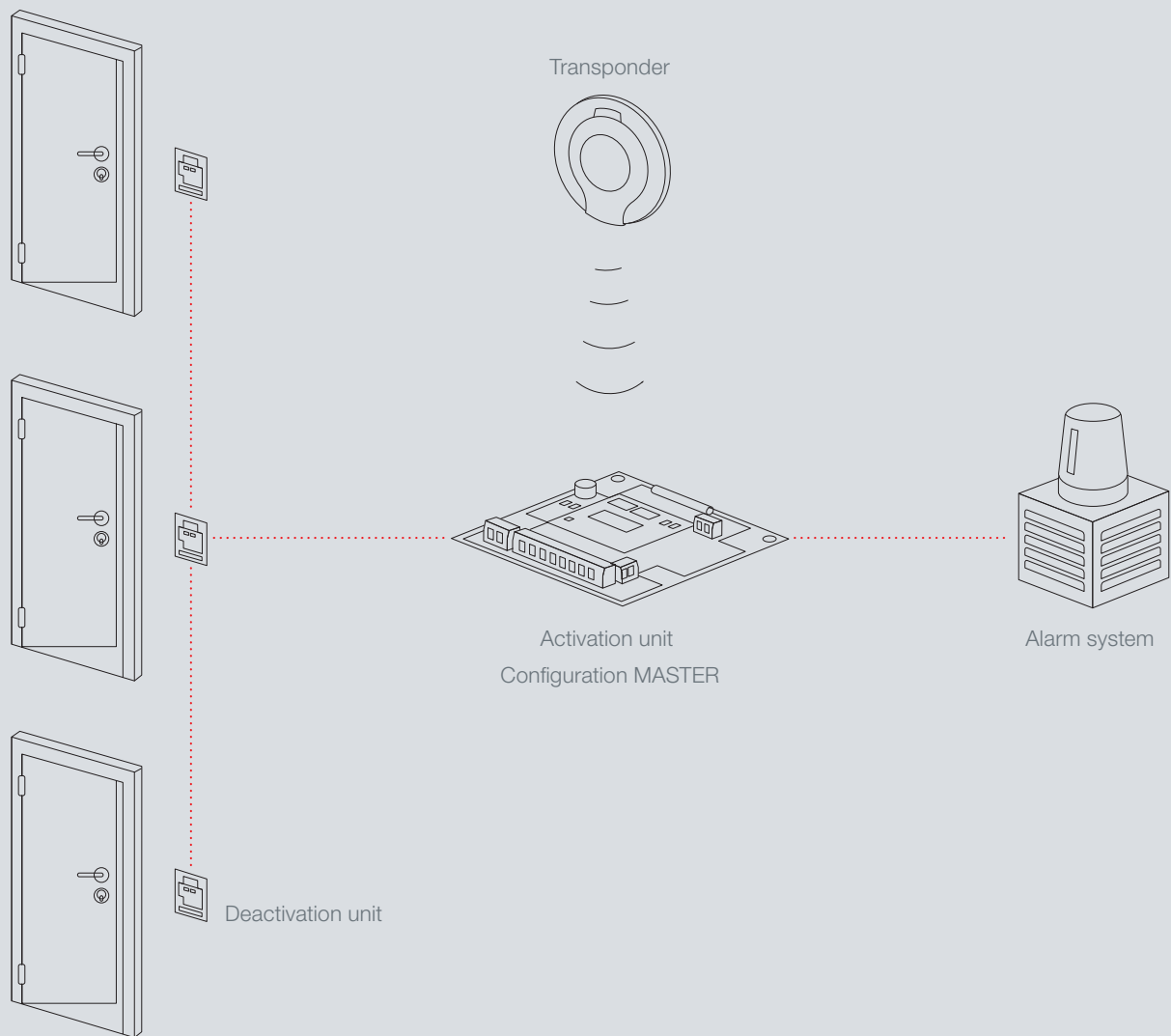

VDS BLOCK LOCK 3066

G1

The block lock function enables users to arm and disarm alarm systems in compliance with VdS regulations using an authorised transponder in System 3060. The alarm system can only be armed if all doors within the security area are locked. As soon as the alarm system is armed, the secured doors can no longer be opened inadvertently (unavoidable). The doors can still be opened in an emergency, such as a fire.

The block lock function is implemented, firstly, by activation units (a master plus additional slaves if required) controlled by transponders. Deactivation units also prevent unintentional entry into the alarm-protected area as they deactivate locking cylinders or Smart Relays when armed, thus stopping doors from being opened.

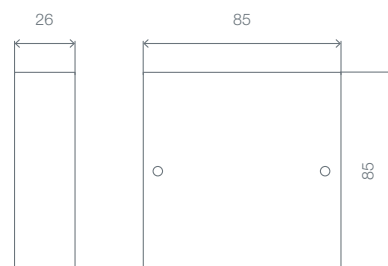

Measurements indicated in mm

TECHNICAL SPECIFICATIONS

- ⚡ White ABS plastic housing
- ⚡ Dimensions: 85 x 85 x 26 mm (H x W x D)
- ⚡ Protection rating: VdS environmental class: II
- ⚡ VdS no.: G101 160
- ⚡ Operating voltage: 8 to 16 V DC
- ⚡ Power consumption: < 30 mA
- ⚡ Relay permanent current: max. 1 A; relay switch-on current: max. 1 A
- ⚡ Relay switching current: max. 40 V AC; relay switching power: max. 30 W / 60 V A
- ⚡ Cover contact - normally open contact: 1 A / 30 V DC
- ⚡ Typical transponder read range in a VdS-compliant installation with separate antenna: about 2 cm
- ⚡ Temperature range: -10 °C to +55 °C

VDS BLOCK LOCK 3066

PRODUCT VERSIONS

| | |
|---|-----------------|
| Block lock activation unit as master with VdS approval up to Class C/SG6 with access control, time zone control and event logging | BS.SCHALT.VDS.M |
| Block lock activation unit as slave with VdS approval up to Class C/SG6 with access control, time zone control and event logging | BS.SCHALT.VDS.S |
| Block lock deactivation unit as slave with VdS approval up to Class C/SG6 | BS.DEAK.VDS |
| Version with separate antenna | .AV |
| Aluminium sleeve for separate antenna, reduces the read range of separate antenna to 2 cm | BV10.010500 |

ACTIVE TECHNOLOGY

OTHER PRODUCTS



DIGITAL SWITCHGEAR CABINET HANDLES

G1

G2



PRODUCT VERSIONS

| | |
|---|------------|
| Digital switchgear cabinet handle with standard 19" system holes; can be integrated into any SimonsVoss System 3060 | SL2.IEG |
| Digital switchgear cabinet handle with standard 19" system holes for round support; can be integrated into any SimonsVoss System 3060 | SL2.IEG.RG |
| Version with access control, time zone management and events logging | .ZK |
| Version with G2 functionality | .G2 |

DIGITAL LEVER LOCKS

G1

G2



PRODUCT VERSIONS

| | |
|---|-------------|
| Digital lever lock; lock body 20 mm long; can be integrated into any SimonsVoss System 3060 | SL2.IEHS-20 |
| Version with access control, time zone management and events logging | .ZK |
| Version with G2 functionality | .G2 |

DIGITAL PADLOCKS

G2



TECHNICAL SPECIFICATIONS:

- ⌘ Dimensions: (W x H x D) with cylinder thumb-turn
60 x 72.5 x 25 mm
- ⌘ Shackle diameter: 11 mm
- ⌘ Versions: Padlock 2 (PL2): non-self-locking
Padlock 3 (PL3): self-locking
- ⌘ Inside height of shackle: PL2: 35 mm
PL3 (self-locking) 50 mm
- ⌘ Protection rating: IP66
- ⌘ Battery type: 2x CR2450, 3 V, lithium.
- ⌘ Battery life:
Up to 300,000 operations or 10 years on standby
- ⌘ Temperature range:
Operational: -25°C to +55°C
In storage (temporary): -45°C to +70°C
In storage (long-term): 0°C to +30°C
- ⌘ Up to 3,000 access events can be stored
- ⌘ Time zone groups: 5+1 (G1), 100+1 (G2)
- ⌘ Up to 8,000 (G1) transponders or
up to 64,000 (G2) transponders can be managed per padlock
- ⌘ Up to 304,000 transponders can be managed per locking device
- ⌘ G1: Different permanent/open modes
- ⌘ Network-ready with integrated Lock Node
- ⌘ Freely configurable

PRODUCT VERSIONS

| | |
|--|--------------|
| SimonsVoss Padlock G1 | PL2.WP |
| SimonsVoss Padlock G1 ZK | PL2.ZK.WP |
| SimonsVoss Padlock G2 | PL2.WP.G2 |
| SimonsVoss Padlock G2 ZK | PL2.ZK.WP.G2 |
| SimonsVoss Self-Locking Padlock G1 | PL3.WP |
| SimonsVoss Self-Locking Padlock G1 ZK | PL3.ZK.WP |
| SimonsVoss Self-Locking Padlock G2 | PL3.WP.G2 |
| SimonsVoss Self-Locking Padlock G2 ZK | PL3.ZK.WP.G2 |
| 'Network Inside' version with integrated Lock Node | WNM.LN.I |

PASSIVE SMART CARD-TECHNOLOGY



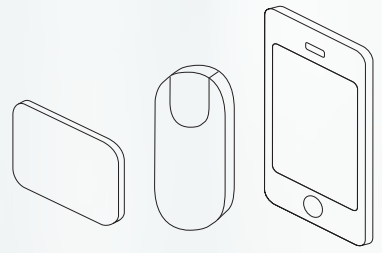

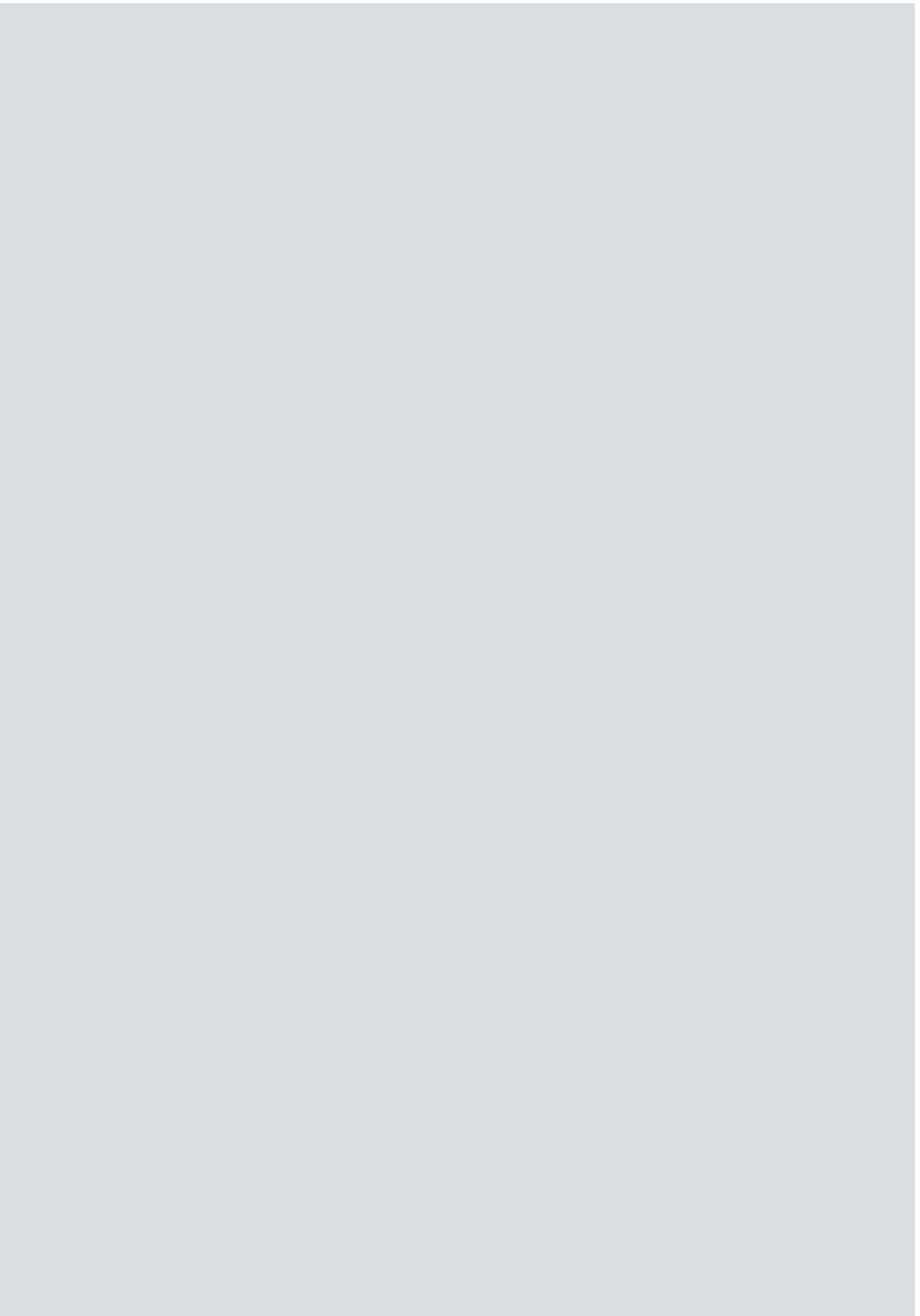

PASSIVE SMART CARD TECHNOLOGY
IDENTIFICATION MEDIA
AND THEIR PROGRAMMING



SMART CARDS SMART TAGS

G1

G2

SimonsVoss has very recently introduced purely passive components in addition to its time-tested active technology and hybrid versions. These components can be addressed using smart cards or smart tags – MIFARE® Classic, MIFARE® DESFire® and MIFARE Plus®. There is also the option of using existing cards in System 3060.



TECHNICAL SPECIFICATIONS

- ⚙ ISO 7816 format
- ⚙ White (unprinted)

PRODUCT VERSIONS

SMART CARD MIFARE® CLASSIC

| | |
|---------------------------------------|------------------|
| 1k memory, white; contains: 5 units | TRA.MIFARE1K.5 |
| 1k memory, white; contains: 100 units | TRA.MIFARE1K.100 |
| 4k memory, white; contains: 5 units | TRA.MIFARE4K.5 |
| 4k memory, white; contains: 100 units | TRA.MIFARE4K.100 |

SMART CARD MIFARE® DESFIRE® (G2 ONLY)

| | |
|---------------------------------------|-------------------|
| 2k memory, white; contains: 5 units | TRA.DESFIRE2K.5 |
| 2k memory, white; contains: 100 units | TRA.DESFIRE2K.100 |
| 4k memory, white; contains: 5 units | TRA.DESFIRE4K.5 |
| 4k memory, white; contains: 100 units | TRA.DESFIRE4K.100 |
| 8k memory, white; contains: 5 units | TRA.DESFIRE8K.5 |
| 8k memory, white; contains: 100 units | TRA.DESFIRE8K.100 |

SMART CARDS
SMART TAGS

SMART CARD MIFARE Plus® (G2 ONLY)

| | |
|--|-----------------|
| Smart card MIFARE Plus® S, 2k memory, white; contains: 5 units | TRA.PLUSS2K.5 |
| Smart card MIFARE Plus® S, 2k memory, white; contains: 100 units | TRA.PLUSS2K.100 |
| Smart card MIFARE Plus® S, 4k memory, white; contains: 5 units | TRA.PLUSS4K.5 |
| Smart card MIFARE Plus® S, 4k memory, white; contains: 100 units | TRA.PLUSS4K.100 |
| Smart card MIFARE Plus® X, 2k memory, white; contains: 5 units | TRA.PLUSX2K.5 |
| Smart card MIFARE Plus® X, 2k memory, white; contains: 100 units | TRA.PLUSX2K.100 |
| Smart card MIFARE Plus® X, 4k memory, white; contains: 5 units | TRA.PLUSX4K.5 |
| Smart card MIFARE Plus® X, 4k memory, white; contains: 100 units | TRA.PLUSX4K.100 |

SMART TAGS MIFARE® CLASSIC / DESFIRE®

| | |
|--|-----------------------|
| Smart tag MIFARE® Classic, 1k memory, black/white with SimonsVoss logo; contains: 5 units | TRA.TAG.MIFARE1K.5 |
| Smart tag MIFARE® Classic, 1k memory, black/white with SimonsVoss logo; contains: 100 units | TRA.TAG.MIFARE1K.100 |
| Smart tag MIFARE® Classic, 4k memory, black/white with SimonsVoss logo; contains: 5 units | TRA.TAG.MIFARE4K.5 |
| Smart tag MIFARE® Classic, 4k memory, black/white with SimonsVoss logo; contains: 100 units | TRA.TAG.MIFARE4K.100 |
| Smart tag MIFARE® DESFire®, 2k memory, black/white with SimonsVoss logo; contains: 5 units | TRA.TAG.DESFIRE2K.5 |
| Smart tag MIFARE® DESFire®, 2k memory, black/white with SimonsVoss logo; contains: 100 units | TRA.TAG.DESFIRE2K.100 |
| Smart tag MIFARE® DESFire®, 4k memory, black/white with SimonsVoss logo; contains: 5 units | TRA.TAG.DESFIRE4K.5 |
| Smart tag MIFARE® DESFire®, 4k memory, black/white with SimonsVoss logo; contains: 100 units | TRA.TAG.DESFIRE4.100 |
| Smart tag MIFARE® DESFire®, 8k memory, black/white with SimonsVoss logo; contains: 5 units | TRA.TAG.DESFIRE8K.5 |
| Smart tag MIFARE® DESFire®, 8k memory, black/white with SimonsVoss logo; contains: 100 units | TRA.TAG.DESFIRE8K.100 |

MOBILE KEY

G2

With Mobile Key, SimonsVoss has developed an all-inclusive solution for using smart phones as digital keys based on near field communication (NFC) technology.

In this solution, smart phones can be used as freely programmable identification media. The data required for identification are transmitted into the phone in encrypted format via a GSM network, so that they can then be used to open SimonsVoss smart card lock media.

The Mobile Key application provides central administration of digital locking systems (digital smart card cylinders, Smart Handle digital door fittings, digital Smart Relay 2, Compact Reader). ID media (smart phones) are networked instead of locking components. Networking to the central administration software (LSM) is achieved via existing mobile networks.

The end user can retrieve their current key from the OTA server via mobile phone networks by pressing the 'Renew key' button on their Mobile Key app and entering a PIN. They can then use their smart phone to open all doors which the locking system administrator has authorised them to use. The smart phone acts like a MIFARE® card.

The locking system administrator needs to specify exact time slots when each user is authorised to gain access. After this time period, the user's 'key' expires and they need to download an updated key.

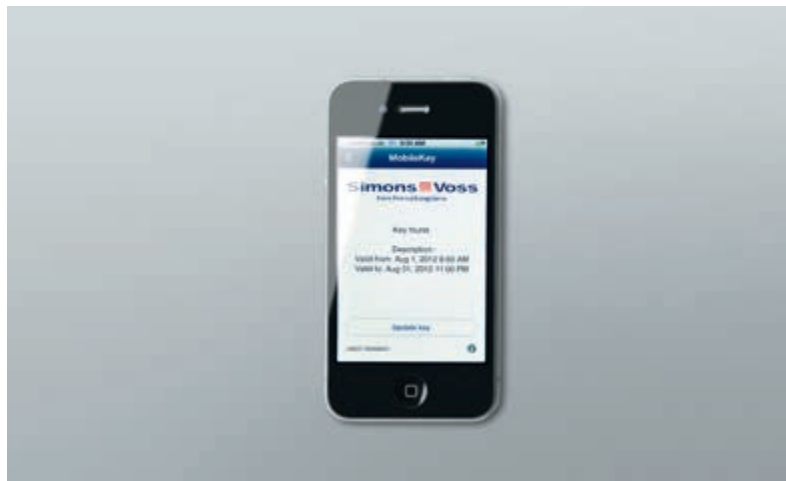

SYSTEM SPECIFICATIONS AND INTERDEPENDENCIES WITH OTHER PRODUCTS

- ⚡ LSM Basic, LSM Business or LSM Professional Editions, Version LSM 3.1 SP2 or higher
- ⚡ The 'NFC' module needs to be enabled in LSM
- ⚡ All SimonsVoss smart card products in G2 systems can be used together with NFC and MIFARE® Classic and/or transponders (NFC with MIFARE® DESFire® in pipeline)
- ⚡ NFC-based smart phones

TECHNICAL SPECIFICATIONS

- ⚡ Card technologies: MIFARE® Classic; MIFARE® DESFire® in pipeline
- ⚡ IPHONE4.ADAPTER.NFC:
iOS operating system + NFC adapter
- ⚡ MICROSD.SAMSUNG.S23.NFC:
Android operating system + Galaxy S2/3 with microSD
- ⚡ IPHONE5.ADAPTER.NFC:
iOS operating system + NFC adapter for iPhone 5
- ⚡ Security: End-to-end encryption between LSM and smart phone app (to be issued by locking system administrator)
- ⚡ Smart phone app: The Mobile Key app is used as a user interface and writes the card data into the secure element (SE = secure data memory)

MOBILE KEY

PRODUCT VERSIONS

IPHONE4® adapter

With NFC-technology and secure element to use smart card locking devices in conjunction with SimonsVoss app (free download from Apple App Store). The LSM.NFC module is required to use MOBILEKEY.NFC. The solution uses MIFARE® Classic technology (MIFARE® DESFire® in pipeline).

IPHONE4.ADAPTER.NFC

IPHONE5® adapter

With NFC-technology and secure element to use smart card locking devices in conjunction with SimonsVoss app (free download from Apple App Store). The LSM.NFC module is required to use MOBILEKEY.NFC. The solution uses MIFARE® Classic technology (MIFARE® DESFire® in pipeline).

IPHONE5.ADAPTER.NFC

Micro SD card for Samsung Galaxy SII and SIII

With NFC-technology and secure element to use smart card locking devices in conjunction with SimonsVoss app (free download at Google Play). The LSM.NFC module is required to use MOBILEKEY.NFC. The solution uses MIFARE® Classic technology (MIFARE® DESFire® in pipeline).

MICROSD.SAMSUNG.S23.NFC

SMART READER 3078

G1

Smart Reader 3078 enables contactless MIFARE® Classic cards to be used in the System 3060. Access information is stored securely in a password-protected area of Classic cards. The card holder is only granted access if authorised.

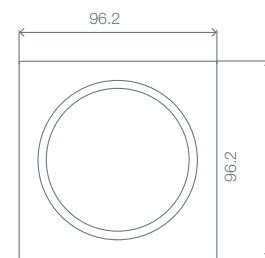

Measurements indicated in mm

TECHNICAL SPECIFICATIONS

- ⚡ Silver or white ABS plastic housing
- ⚡ Dimensions: 96.2 x 96.2 x 14.4 mm (H x W x D)
- ⚡ Weight: about 102 g with battery
- ⚡ Protection rating: IP65 with battery; with power supply unit: IP54
- ⚡ Typical read range: up to 30 cm to the locking cylinder/ Smart Handle; up to 60 cm to Smart Relay
- ⚡ Battery type: 1 x AA, 3.6V, lithium
- ⚡ Battery life: up to 80,000 lock operations or up to ten years on standby
- ⚡ Temperature range: with battery: +6 °C to +60 °C; with power supply unit: -10 °C to +60 °C
- ⚡ LED indicates fault-free/incorrect operation
- ⚡ Yellow LED indicates Battery Warning Levels 1 and 2; the locking device is opened after a 10 or 20 second delay
- ⚡ The lock can still be opened with an authorised transponder even when the Smart Reader battery is completely flat
- ⚡ Cable-free surface mount (battery-operated version)
- ⚡ Option of connecting external antenna

PRODUCT VERSIONS

Smart Reader 3078

| | |
|---|---------------------|
| Battery-operated Smart Reader as converter from passive technology to SimonsVoss active technology for contactless MIFARE® Classic smart cards, in silver housing | TRA.NFC.MF1K.AP |
| Version in white housing | .W |
| Version with connection for external power supply unit | .NT |
| External antenna for connection to Smart Reader | WN.LN.ANTV |
| External plug-in power supply for Smart Reader | WN.POWER.SUPPLY.PPP |

COMPACT READER 3078

G2

The Compact Reader allows any active System 3060 G2 locking component to be extended for use with MIFARE® Classic and MIFARE® DESFire® smart cards.

Thanks to its very compact and attractive design, it can be attached to any door with either adhesive pads or two screws.

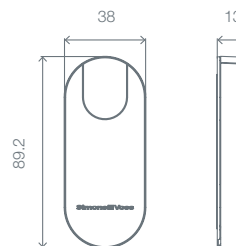

Measurements indicated in mm

TECHNICAL SPECIFICATIONS

- ⚡ Silver or white ASA plastic housing
- ⚡ Dimensions: 89.22 x 38.06 x 12.90 mm (H x W x D)
- ⚡ Weight: about 45 g with battery
- ⚡ Protection category version .WP: IP65 (only when bonded)
- ⚡ Supports MIFARE® Classic and MIFARE® DESFire® media
- ⚡ Typical read range: up to 30 cm to the locking cylinder/
Smart Handle: up to 60 cm to Smart Relay
- ⚡ Battery type: 2 x CR2450, 3 V, lithium
- ⚡ Battery life: up to 80,000 actuations* or up to ten years on stand-by
- ⚡ Temperature range: -20 °C to +50 °C
- ⚡ Visual feedback signal from blue/red LED
- ⚡ Blue/red LED indicates Battery Warning Levels 1 and 2, locks are only activated after delays of varying length
- ⚡ Lock Node for direct networking of Compact Reader
- ⚡ 100 time zone groups
- ⚡ Up to 64,000 transponders can be managed per Compact Reader (depending on the locking system configuration)
- ⚡ Up to 32,000 locks can be managed per smart card (depending on available memory on the smart card and the locking system configuration)
- ⚡ The lock can still be opened with an authorised transponder even when the Compact Reader batteries are completely flat
- ⚡ Cable-free surface mount

*Up to 60,000 lock operations with access logging on the smart card

PRODUCT VERSIONS

| | |
|---|---------------|
| Compact Reader 3078 | |
| To integrate all active G2 components in System 3060. Operated with contactless smart cards based on MIFARE® Classic and MIFARE® DESFire®; in silver housing, for indoors | |
| | TRA.CR.MIFARE |
| Version in white housing | .W |
| Version for outdoor areas (weatherproof design) | .WP |
| 'Network Inside' version with integrated lock node for auto-configuration (cannot be retrofit) | .WNM |

PROGRAMMING

Programming Device SMARTCD.MP



There are different options for offline programming, depending on the lock system size:

- ⚡ Large systems are managed with the Locking System Management software (LSM). The lock plan is produced on a PC. The data are then transferred to the digital components using Programming Device Smart CD
- ⚡ Alternatively, lock plans can be transferred to a PDA (for hybrid components only)/netbook which communicates with the Smart CD using Bluetooth or USB.
- ⚡ Can also be programmed online; see Multi-networking.

TECHNICAL SPECIFICATIONS FOR SMART CD – G2

- ⚡ Housing made of dark-grey polyamide
- ⚡ Dimensions: 112 x 63 x 22 mm (H x W x D)
- ⚡ Protection rating: IP 20
- ⚡ Battery type: 2 rechargeable li-ion manganese batteries
- ⚡ Recharged via USB port
- ⚡ Temperature range: -5 °C to +40 °C

TECHNICAL SPECIFICATIONS FOR SMART CD.HF

For MIFARE® Classic and MIFARE® DESFire® smart cards

- ⚡ Can only be used together with Smart CD – G2 to programme hybrid components

TECHNICAL SPECIFICATIONS FOR SMARTCD.MP

For SC cylinders, smart cards and smart tags

- ⚡ Housing made of dark-grey polyamide
- ⚡ Dimensions: 112 x 63 x 22 mm (HxWxD)
- ⚡ Protection rating: IP20
- ⚡ Power supply via USB port
- ⚡ Temperature range: -5 °C to +60 °C

PROGRAMMING

Programming device for MIFARE® Classic and MIFARE® DESFire® smart cards



PRODUCT VERSIONS

PROGRAMMING DEVICES

| | |
|---|-------------|
| <p>Programming device To connect to a USB port on a PC or laptop. Can also be operated online as a portable device with a netbook or touchbook To programme SimonsVoss SC locking devices and MIFARE® Classic, MIFARE Plus® and MIFARE® DESFire® smart cards or smart tags</p> | SMARTCD.MP |
| <p>Programming device For MIFARE® Classic and MIFARE® DESFire® smart cards and smart tags; can only be used in conjunction with SmartCD – G2</p> | SMARTCD.HF |
| <p>Programming device To connect to a USB port on a PC or laptop. Can be operated using Bluetooth on a Windows Mobile PDA (approved device: PDA.XX.DE) as a portable solution. Included in supply package: Programming Device Smart CD, CD ROM with manual and USB drivers, 2 integrated rechargeable batteries. Required software: a SimonsVoss lock plan software is always needed when used with a PC or laptop. LSM Mobile Edition is also required when used with a PDA. Programming Device SMARTCD.HF is also required when programming hybrid locking devices.</p> | SMART CD.G2 |
| <p>Programming device For MIFARE® Classic smart cards and smart tags; is only required in conjunction with the Smart Reader 3078; cannot programme locks</p> | CD.MIFARE |
| <p>PDA (Subject to technical changes) with Windows Mobile operating system and Bluetooth technology; used in combination with SmartCD and LSM Mobile Edition as programming device for active and hybrid System 3060 components (SmartCD and LSM Mobile Edition are not included and must be ordered separately)</p> | PDA.XX.DE |
| <p>Netbook (Subject to technical changes) with Windows 7 Starter operating system; used in conjunction with Smart CD and LSM Mobile Edition as a programming device for System 3060 (SmartCD and LSM Mobile Edition are not included in the supplied package and must be ordered separately)</p> | NB.WM.ML |

PASSIVE SMART CARD TECHNOLOGY
DIGITAL LOCKING CYLINDER
3061 – SC



DIGITAL EURO PROFILE DOUBLE THUMB-TURN CYLINDER 3061 – SC – COMFORT

G2

Digital Locking Cylinder – SC with an enclosed electronics assembly as per DIN 18252 / DIN EN 15684 / EN 1303 for fitting into Euro profile locks as per DIN 18251. Approval for fitting into locks as per DIN 18250

- ⌘ Inner side is permanently engaged
- ⌘ MIFARE® Classic, MIFARE Plus® and MIFARE® DESFire®
- ⌘ Access control, time zone management and events logging
- ⌘ Versions with protection rating IP66
- ⌘ Upgrade for direct networking

The options are endless whether you use direct or virtual networking, worldwide cable-free networking in SimonsVoss WaveNet or a combination with existing SimonsVoss systems.

All versions of the renowned MIFARE® Classic ID card and cards based on MIFARE Plus® or MIFARE® DESFire® technology can be read. The new cylinder is no larger than a conventional digital locking cylinder and is powered in the same way, using standard button cells.

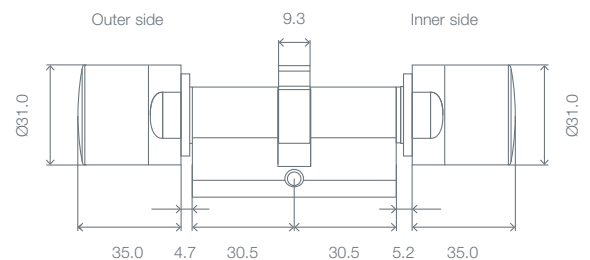

Measurements indicated in mm

TECHNICAL SPECIFICATIONS

- ⌘ Standard Euro Profile cylinder as per DIN 18252 / EN 1303 / DIN EN 15684
- ⌘ Thumb-turn diameter: 31 mm
- ⌘ Basic installation length: 30–30 mm (external/inside dimension)
- ⌘ Overall length: up to 140 mm (max. 90 mm on one side); special lengths on request
- ⌘ Protection rating: IP54; .WP version: IP66
- ⌘ Battery type: 2 x lithium, CR2450, 3 V
- ⌘ Battery life: up to 65,000 lock operations* or up to six years on standby
- ⌘ Temperature range: Operational: -25 °C +65 °C
- ⌘ Audible feedback signal from a buzzer
- ⌘ Visual feedback signal from blue/red LED
- ⌘ Buzzer and blue/red LED indicate Battery Warning Levels 1 and 2; locks are only activated after delays of varying length
- ⌘ 3,000 access events can be saved
- ⌘ 100 time zone groups
- ⌘ Up to 64,000 smart cards can be managed per lock (depending on the locking system configuration)
- ⌘ Up to 32,000 locks can be managed per smart card (depending on available memory on the smart card and the locking system configuration)
- ⌘ Can be directly networked with integrated Lock Node (Network Cover WNM.LN.I.MP)
- ⌘ Freely configurable

*Up to 35,000 lock operations with access logging on the smart card

DIGITAL EURO PROFILE
DOUBLE THUMB-TURN CYLINDER
3061 – SC – COMFORT

PRODUCT VERSIONS

| | |
|--|------------------------|
| Digital Euro Profile Double Thumb-turn Cylinder 3061 – SC – Comfort with G2 functions Installation length 30-30 mm, digital comfort cylinder, stainless steel design, internal power supply, rotary thumb-turn on both sides; can be operated from the outside with smart cards/smart tags featuring MIFARE®Classic, MIFARE Plus® and MIFARE® DESFire® technology; no medium required to operate from the inside; no cabling necessary | Z4.30-30.MP.CO.G2 |
| Brass design | .MS |
| Version with access control, time zone management and events logging | .ZK |
| Weatherproof version, protection rating IP66 | .WP |
| 'Network Inside' version with integrated Lock Node | WNM.LN.I.MP |
| INSTALLATION LENGTHS (all length specifications: external - inside): | |
| Overall length from 65 mm to 80 mm | e.g. Z4.40-40.MP.CO.G2 |
| Overall length over 80 mm to 100 mm | e.g. Z4.40-60.MP.CO.G2 |
| Overall length over 100 mm up to max. 140 mm (max. 90 mm on one side) | e.g. Z4.65-75.MP.CO.G2 |
| Overall length over 140 mm or over 90 mm on one side | on request |

DIGITAL EURO PROFILE DOUBLE THUMB-TURN CYLINDER 3061 – SC – FD

G2

Digital Locking Cylinder – SC with an enclosed electronics assembly as per DIN 18252 / DIN EN 15684 / EN 1303 for fitting into Euro profile locks as per DIN 18251. Approval for fitting into locks as per DIN 18250 (fire protection).

- ⌘ MIFARE® Classic, MIFARE Plus® and MIFARE® DESFire®
- ⌘ Freely rotating on both sides – Reader inside and outside
- ⌘ Access control, time zone management and events logging
- ⌘ Versions with protection rating IP66
- ⌘ Upgrade for direct networking

The options are endless whether you use direct or virtual networking, worldwide cable-free networking in SimonsVoss WaveNet or a combination with existing SimonsVoss systems.

All versions of the renowned MIFARE® Classic ID card and cards based on MIFARE Plus® or MIFARE® DESFire® technology can be read. The new cylinder is no larger than a conventional digital locking cylinder and is powered in the same way, using standard button cells.

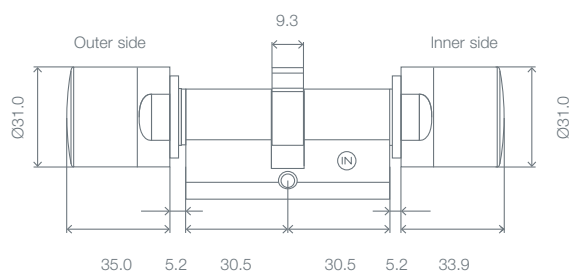

Measurements indicated in mm

TECHNICAL SPECIFICATIONS

- ⌘ Euro Profile Door Monitoring Half Cylinder as per DIN 18252 / EN 1303 / DIN EN 15684, stainless steel design, freely rotating on both sides
- ⌘ Thumb-turn diameter: 31 mm
- ⌘ Basic installation length: 30–30 mm (external/inside dimension)
- ⌘ Overall length: up to 140 mm (max. 90 mm on one side); special lengths on request
- ⌘ Protection rating: IP54; .WP version: IP66
- ⌘ Battery type: 4 x lithium, CR2450, 3 V
- ⌘ Battery life: up to 65,000 lock operations* or up to six years on standby
- ⌘ Temperature range: Operational: -25 °C +65 °C
- ⌘ Audible feedback signal from a buzzer
- ⌘ Visual feedback signal from blue/red LED
- ⌘ Buzzer and blue/red LED indicate Battery Warning Levels 1 and 2; locks are only activated after delays of varying length
- ⌘ 3,000 access events can be saved
- ⌘ 100 time zone groups
- ⌘ Up to 64,000 smart cards can be managed per locking device (depending on the locking system configuration)
- ⌘ Up to 32,000 locking devices can be managed per smart card (depending on available memory on the smart card and the locking system configuration)
- ⌘ Can be directly networked with integrated Lock Node (Network Cover WNM.LN.I.MP)
- ⌘ Freely configurable

*Up to 35,000 lock operations with access logging on the smart card

DIGITAL EURO PROFILE
DOUBLE THUMB-TURN CYLINDER
3061 – SC – FD

PRODUCT VERSIONS

Digital Euro Profile Double Thumb-turn Cylinder 3061 – SC – FD with G2 functions

Installation length 30-30 mm, stainless steel design, freely rotating on both sides, powered internally; can be operated on the inside and outside with smart cards/smart tags featuring MIFARE®Classic, MIFARE Plus® and MIFARE® DESFire® technology; no cabling necessary

Z4.30-30.MP.FD.G2

Brass design

.MS

Version with access control, time zone management and events logging

.ZK

Multi-point lock version for use in doors with multi-point locks

.MR

Weatherproof version, protection rating IP66

.WP

'Network Inside' version with integrated Lock Node

WNM.LN.I.MP

INSTALLATION LENGTHS (all length specifications: external - inside):

Overall length from 65 mm to 80 mm

e.g. Z4.40-40.MP.FD.G2

Overall length over 80 mm to 100 mm

e.g. Z4.40-60.MP.FD.G2

Overall length over 100 mm up to max. 140 mm (max. 90 mm on one side)

e.g. Z4.65-75.MP.FD.G2

Overall length over 140 mm or over 90 mm on one side

on request

DIGITAL EURO PROFILE DOUBLE THUMB-TURN CYLINDER 3061 – SC – ANTI-PANIC

G2

Digital Locking Cylinder – SC with an enclosed electronics assembly as per DIN 18252 / DIN EN 15684 / EN 1303 for fitting into escape doors as per EN 179 and DIN 1125. Approval for fitting into locks as per DIN 18250 (fire protection).

- ⚡ Strong spring-back mechanism
- ⚡ MIFARE® Classic, MIFARE Plus® and MIFARE® DESFire®
- ⚡ Option with free rotation and reader on both sides – Reader unit inside and outside
- ⚡ Access control, time zone management and events logging
- ⚡ Versions with protection rating IP66
- ⚡ Upgrade for direct networking

The options are endless whether you use direct or virtual networking, worldwide cable-free networking in SimonsVoss WaveNet or a combination with existing SimonsVoss systems.

All versions of the renowned MIFARE® Classic ID card and cards based on MIFARE Plus® or MIFARE® DESFire® technology can be read. The new cylinder is no larger than a conventional digital locking cylinder and is powered in the same way, using standard button cells.

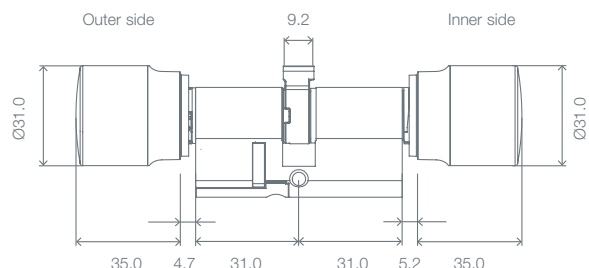
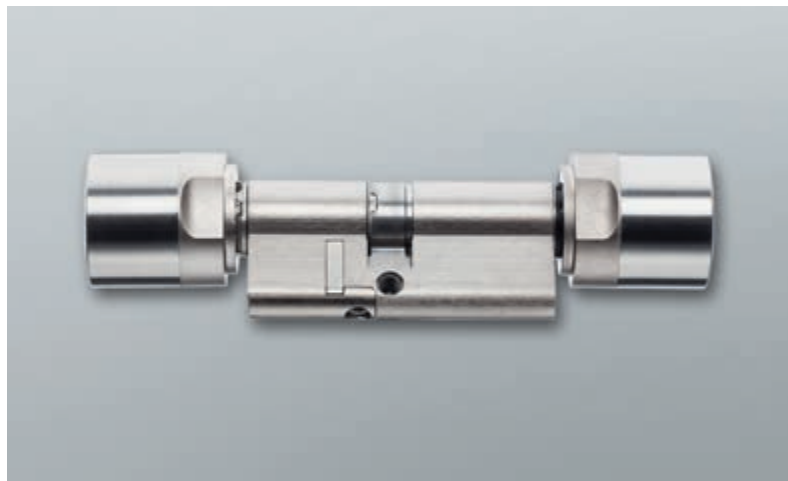

Measurements indicated in mm

TECHNICAL SPECIFICATIONS

- ⚡ Digital Euro Profile Anti-Panic Cylinder as per DIN 18252 / EN 1303 / DIN EN 15684
- ⚡ Thumb-turn diameter: 31 mm
- ⚡ Basic installation length: 30-35 mm (external/inside dimension)
- ⚡ Overall length: up to 140 mm (max. 90 mm on one side); special lengths on request
- ⚡ Protection rating: IP54; .WP version: IP66 (thumb-turns)
- ⚡ Battery type: 2 x lithium, CR2450, 3 V
- ⚡ Battery life: up to 65,000 lock operations* or up to six years on standby
- ⚡ Temperature range: Operational: -25 °C +65 °C
- ⚡ Audible feedback signal from a buzzer
- ⚡ Visual feedback signal from blue/red LED
- ⚡ Buzzer and blue/red LED indicate Battery Warning Levels 1 and 2; locks are only activated after delays of varying length
- ⚡ 3,000 access events can be saved
- ⚡ 100 time zone groups
- ⚡ Up to 64,000 smart cards can be managed per locking device (depending on the locking system configuration)
- ⚡ Up to 32,000 locking devices can be managed per smart card (depending on available memory on the smart card and the locking system configuration)
- ⚡ Can be directly networked with integrated Lock Node (Network Thumb-turn Cover WNM.LN.I.MP)
- ⚡ Freely configurable

*Up to 35,000 lock operations with access logging on the smart card

DIGITAL EURO PROFILE
DOUBLE THUMB-TURN CYLINDER
3061 – SC – ANTI-PANIC

PRODUCT VERSIONS

| | |
|---|-------------------------|
| <p>Digital Euro Profile Double Thumb-turn Cylinder 3061 – SC – Anti-Panic with G2 functions Installation length 30-30 mm, for use in anti-panic locks, stainless steel design, freely rotating on both sides, internal power supply, rotary thumb-turn on both sides; can be operated from outside with smart cards/smart tags featuring MIFARE®Classic, MIFARE Plus® and MIFARE® DESFire® technology; no cabling necessary</p> | Z4.30-30.MP.AP2.FD.G2 |
| <p>Digital Euro Profile Double Thumb-turn Cylinder 3061 – SC – Anti-Panic with G2 functions Installation length 30-30 mm, for use in anti-panic locks, stainless steel design, internal power supply, rotary thumb-turn on both sides; can be operated on the inside and outside with smart cards/smart tags featuring MIFARE®Classic, MIFARE Plus® and MIFARE® DESFire® technology; no cabling necessary</p> | Z4.30-30.MP.AP2.BL.G2 |
| Brass design | .MS |
| Version with access control, time zone management and events logging | .ZK |
| Weatherproof version, protection rating IP66 (thumb-turn) | .WP |
| 'Network Inside' version with integrated Lock Node | WNM.LN.I.MP |
| INSTALLATION LENGTHS (all length specifications: external - inside): | |
| Overall length from 65 mm to 80 mm | e.g. Z4.40-40.MP.AP2.G2 |
| Overall length over 80 mm to 100 mm | e.g. Z4.40-60.MP.AP2.G2 |
| Overall length over 100 mm up to max. 140 mm (max. 90 mm on one side) | e.g. Z4.65-75.MP.AP2.G2 |
| Overall length over 140 mm or over 90 mm on one side | on request |

DIGITAL EURO PROFILE HALF CYLINDER 3061 – SC

G2

Digital Half Cylinder - SC with an enclosed electronics assembly as per DIN 18252 / DIN EN 15684 / EN 1303 for fitting into Euro profile locks as per DIN 18251 for special applications, such as use on garage doors or in lockers:

- ⚡ MIFARE® Classic, MIFARE Plus® and MIFARE® DESFire®
- ⚡ Optional access control, events logging and time zone management
- ⚡ Versions with protection rating IP66
- ⚡ Upgrade for direct networking

The options are endless whether you use direct or virtual networking, worldwide cable-free networking in SimonsVoss WaveNet or a combination with existing SimonsVoss systems.

All versions of the renowned MIFARE® Classic ID card and cards based on MIFARE Plus® or MIFARE® DESFire® technology can be read. The new cylinder is no larger than a conventional digital locking cylinder and is powered in the same way, using standard button cells.

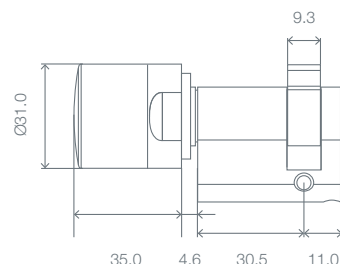

Measurements indicated in mm

TECHNICAL SPECIFICATIONS

- ⚡ Digital Euro Profile Half Cylinder as per DIN 18252 / EN 1303 / DIN EN 15684
- ⚡ Thumb-turn diameter: 31 mm
- ⚡ Basic installation length: 30-10 mm (external/inside dimension)
- ⚡ Overall length: up to 100 mm (max. 90 mm on one side); special lengths on request
- ⚡ Protection rating: IP54; .WP version: IP66
- ⚡ Battery type: 2 x lithium, CR2450, 3 V
- ⚡ Battery life: up to 65,000 lock operations* or up to six years on standby
- ⚡ Temperature range: Operational: -25 °C +65 °C
- ⚡ Audible feedback signal from a buzzer
- ⚡ Visual feedback signal from blue/red LED
- ⚡ Buzzer and blue/red LED indicate Battery Warning Levels 1 and 2; locks are only activated after delays of varying length
- ⚡ 3,000 access events can be saved
- ⚡ 100 time zone groups
- ⚡ Up to 64,000 smart cards can be managed per locking device (depending on the locking system configuration)
- ⚡ Up to 32,000 locking devices can be managed per smart card (depending on available memory on the smart card and the locking system configuration)
- ⚡ Can be directly networked with integrated Lock Node (Network Thumb-turn Cover WNM.LN.I.MP)
- ⚡ Freely configurable

*Up to 35,000 lock operations with access logging on the smart card

DIGITAL EURO PROFILE
HALF CYLINDER 3061 – SC

PRODUCT VERSIONS

| | |
|---|-------------------|
| Digital Euro Profile Half Cylinder 3061 – SC with G2 functions Installation length 30-10 mm, stainless steel design; thumb-turn cannot be detached; internal power supply; can be operated from outside with smart cards/smart tags featuring MIFARE®Classic, MIFARE Plus® and MIFARE® DESFire® technology; no cabling necessary | Z4.30-10.MP.HZ.G2 |
| Brass design | .MS |
| Version with access control, time zone management and events logging | .ZK |
| Version with detachable thumb-turn | .DK |
| Multi-point version, thumb-turn detachable | .MR |
| Weatherproof version, protection rating IP66 | .WP |
| 'Network Inside' version with integrated Lock Node | WNM.LN.I.MP |

INSTALLATION LENGTHS (all length specifications: external - inside):

| | |
|-------------------------------------|------------------------|
| Overall length from 45 mm to 70 mm | e.g. Z4.60-10.MP.HZ.G2 |
| Overall length over 80 mm to 100 mm | e.g. Z4.80-10.MP.HZ.G2 |
| Overall length over 100 mm | on request |

DIGITAL SCANDINAVIAN OVAL CYLINDER 3061 – SC

G2

Digital Locking Cylinder – SC with an enclosed electronics assembly as per DIN EN 15684 / EN 1303 for fitting into doors with a Scandinavian oval profile:

- ⌘ MIFARE® Classic, Plus® and DESFire®
- ⌘ Optional access control, events logging and time zone management
- ⌘ Versions with protection rating IP66
- ⌘ Upgrade for direct networking

The options are endless whether you use direct or virtual networking, worldwide cable-free networking in SimonsVoss WaveNet or a combination with existing SimonsVoss systems.

All versions of the renowned MIFARE® Classic ID card and cards based on MIFARE Plus® or MIFARE® DESFire® technology can be read. The new cylinder is no larger than a conventional digital locking cylinder and is powered in the same way using standard button cells.

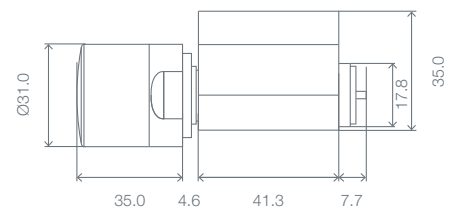

Measurements indicated in mm

TECHNICAL SPECIFICATIONS

- ⌘ Digital Scandinavian Oval Cylinder
- ⌘ Thumb-turn diameter: 31 mm
- ⌘ Basic installation length: 41.3 mm (external/inside dimension)
- ⌘ Overall length: max. 86.3 mm; special lengths on request
- ⌘ Protection rating: IP54; .WP version; IP66
- ⌘ Battery type: 2 x lithium CR2450 3 V
- ⌘ Battery life: up to 65,000 lock operations* or up to six years on standby
- ⌘ Temperature range: Operational: -25 °C +65 °C
- ⌘ Audible feedback signal from a buzzer
- ⌘ Visual feedback signal from blue/red LED
- ⌘ Buzzer and blue/red LED indicate Battery Warning Levels 1 and 2; locks are only activated after delays of varying length
- ⌘ 3,000 access events can be saved
- ⌘ 100 time zone groups
- ⌘ Up to 64,000 smart cards can be managed per locking device (depending on the locking system configuration)
- ⌘ Up to 32,000 locking devices can be managed per smart card (depending on available memory on the smart card and the locking system configuration)
- ⌘ Can be directly networked with integrated Lock Node (Network Cover WNM.LN.I.MP)
- ⌘ Freely configurable

*Up to 35,000 lock operations with access logging on the smart card

DIGITAL SCANDINAVIAN
OVAL CYLINDER 3061 – SC

PRODUCT VERSIONS

Digital Scandinavian Oval Cylinder 3061 – SC with G2 functions

Installation length 41.3 mm, stainless steel design, internal power supply; can be operated from outside with smart cards/smart tags featuring MIFARE®Classic, MIFARE Plus® and MIFARE® DESFire® technology; no cabling necessary

Z4.SO.A40.MP.G2

Brass design

.MS

Version with access control, time zone management and events logging

.ZK

Weatherproof version, protection rating IP66

.WP

'Network Inside' version with integrated Lock Node

WNM.LN.I.MP

INSTALLATION LENGTHS (all length specifications: external - inside):

Overall length from 43.3 mm to 61.3 mm

e.g. Z4.SO.A60.MP.G2

Overall length over 66.3 mm to 86.3 mm

e.g. Z4.SO.A80.MP.G2

Overall length over 86.3 mm

on request

SCANDINAVIAN ROUND CYLINDER 3061 – SC

G2

Digital Locking Cylinder – SC with an enclosed electronics assembly as per DIN EN 15684 / EN 1303 for fitting into doors with a Scandinavian round profile:

- ⌘ MIFARE® Classic, Plus® and DESFire®
- ⌘ Optional access control, events logging and time zone management
- ⌘ Versions with protection rating IP66
- ⌘ Upgrade for direct networking

The options are endless whether you use direct or virtual networking, worldwide cable-free networking in SimonsVoss WaveNet or a combination with existing SimonsVoss systems.

All versions of the renowned MIFARE® Classic ID card and cards based on MIFARE Plus® or MIFARE® DESFire® technology can be read. The new cylinder is no bigger than a conventional digital locking cylinder and is powered in the same way using standard button cells.

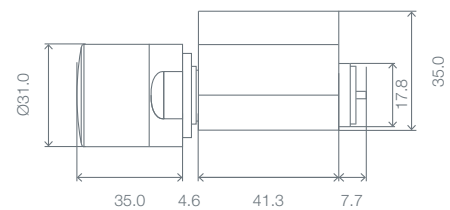

Measurements indicated in mm

TECHNICAL SPECIFICATIONS

- ⌘ Digital Scandinavian Round Cylinder
- ⌘ Thumb-turn diameter: 31 mm
- ⌘ Basic installation length: 41.3 mm (external/inside dimension)
- ⌘ Overall length: max. 86.3 mm; special lengths on request
- ⌘ Protection rating: IP54; .WP version: IP66
- ⌘ Battery type: 2 x lithium CR2450 3 V
- ⌘ Battery life: up to 65,000 lock operations* or up to six years on standby
- ⌘ Temperature range: Operational: -25 °C +65 °C
- ⌘ Audible feedback signal from a buzzer
- ⌘ Visual feedback signal from blue/red LED
- ⌘ Buzzer and blue/red LED indicate Battery Warning Levels 1 and 2; locks are only activated after delays of varying length
- ⌘ 3,000 access events can be saved
- ⌘ 100 time zone groups
- ⌘ Up to 64,000 smart cards can be managed per locking device (depending on the locking system configuration)
- ⌘ Up to 32,000 locking devices can be managed per smart card (depending on available memory on the smart card and the locking system configuration)
- ⌘ Can be directly networked with integrated Lock Node (Network Cover WNM.LN.I.MP)
- ⌘ Freely configurable

*Up to 35,000 lock operations with access logging on the smart card

DIGITAL SCANDINAVIAN
ROUND CYLINDER
3061 – SC

PRODUCT VERSIONS

Digital Scandinavian Round Cylinder 3061 – SC with G2 functions

Installation length 41.3 mm, stainless steel design, internal power supply; can be operated from outside with smart cards/smart tags featuring MIFARE®Classic, MIFARE Plus® and MIFARE® DESFire® technology; no cabling necessary

Z4.RS.A40.MP.G2

Brass design

.MS

Version with access control, time zone management and events logging

.ZK

Weatherproof version, protection rating IP66

.WP

'Network Inside' version with integrated Lock Node

WNM.LN.I.MP

INSTALLATION LENGTHS (all length specifications: external - inside):

Overall length from 43.3 mm to 61.3 mm

e.g. Z4.RS.A60.MP.G2

Overall length over 66.3 mm to 86.3 mm

e.g. Z4.RS.A80.MP.G2

Overall length over 86.3 mm

on request

DIGITAL SWISS ROUND DOUBLE THUMB-TURN CYLINDER 3061 – SC

G2

Digital Locking Cylinder – SC with an enclosed electronics assembly as per DIN EN 15684 / EN 1303 for fitting into doors with a Swiss round profile:

- ⌘ Internal side is permanently engaged
- ⌘ MIFARE® Classic, Plus® and DESFire®
- ⌘ Optional access control, events logging and time zone management
- ⌘ Versions with protection rating IP66
- ⌘ Upgrade for direct networking

The options are endless whether you use direct or virtual networking, worldwide cable-free networking in SimonsVoss WaveNet or a combination with existing SimonsVoss systems.

All versions of the renowned MIFARE® Classic ID card and cards based on MIFARE Plus® or MIFARE® DESFire® technology can be read. The new cylinder is no bigger than a conventional digital locking cylinder and is powered in the same way using standard button cells.

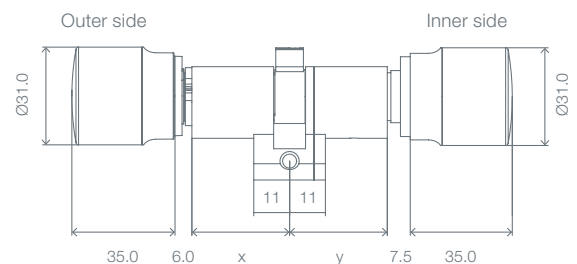
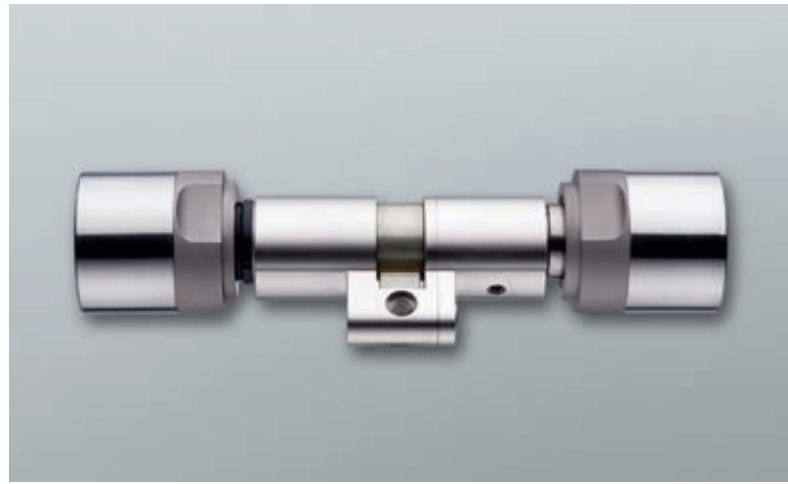

Measurements indicated in mm

TECHNICAL SPECIFICATIONS

- ⌘ Digital Swiss Round Double Thumb-turn Cylinder – Comfort
- ⌘ Inner thumb-turn can be operated without smart card
- ⌘ Thumb-turn diameter: 31 mm
- ⌘ Basic installation length: 30–30 mm (external/inside dimension)
- ⌘ Overall length: up to 140 mm (max. 90 mm on one side); special lengths on request
- ⌘ Protection rating: IP54; .WP version; IP66
- ⌘ Battery type: 2 x lithium, CR2450, 3 V
- ⌘ Battery life: up to 65,000 lock operations* or up to six years on standby
- ⌘ Temperature range: Operational: -25 °C +65 °C
- ⌘ Audible feedback signal from a buzzer
- ⌘ Visual feedback signal from blue/red LED
- ⌘ Buzzer and blue/red LED indicate Battery Warning Levels 1 and 2; locks are only activated after delays of varying length
- ⌘ 3,000 access events can be saved
- ⌘ 100 time zone groups
- ⌘ Up to 64,000 smart cards can be managed per locking device (depending on the locking system configuration)
- ⌘ Up to 32,000 locking devices can be managed per smart card (depending on available memory on the smart card and the locking system configuration)
- ⌘ Can be directly networked with integrated Lock Node (Network Thumb-turn Cover WNM.LN.I.MP)
- ⌘ Freely configurable

*Up to 35,000 lock operations with access logging on the smart card

DIGITAL SWISS ROUND
DOUBLE THUMB-TURN CYLINDER
3061 – SC

PRODUCT VERSIONS

| | |
|--|---------------------------|
| <p>Digital Swiss Round Double Thumb-turn Cylinder 3061 – SC with G2 functions Installation length 30-30 mm, digital comfort cylinder, stainless steel design, internal power supply, rotary thumb-turn on both sides; can be operated from the outside with smart cards/smart tags featuring MIFARE®Classic, MIFARE Plus® and MIFARE® DESFire® technology; no medium required to operate from the inside; no cabling necessary</p> | Z4.SR.30-30.MP.CO.G2 |
| Brass design | .MS |
| Version with access control, time zone management and events logging | .ZK |
| Weatherproof version, protection rating IP66 | .WP |
| 'Network Inside' version with integrated Lock Node | WNM.LN.I.MP |
| <p>INSTALLATION LENGTHS (all length specifications: external - inside):</p> | |
| Overall length from 65 mm to 80 mm | e.g. SR.Z4.40-40.MP.CO.G2 |
| Overall length over 80 mm to 100 mm | e.g. SR.Z4.40-60.MP.CO.G2 |
| Overall length over 100 mm up to max. 140 mm (max. 90 mm on one side) | e.g. SR.Z4.65-75.MP.CO.G2 |
| Overall length over 140 mm or over 90 mm on one side | on request |

DIGITAL SWISS ROUND HALF CYLINDER 3061 – SC

G2

Digital Half Cylinder - SC with an enclosed electronics assembly as per DIN EN 15684 / EN 1303 for fitting into Swiss round profile for special applications, such as use on garage doors or in lockers:

- ⌘ MIFARE® Classic, Plus® and DESFire®
- ⌘ Access control, time zone management and events logging
- ⌘ Versions with protection rating IP66
- ⌘ Upgrade for direct networking

The options are endless whether you use direct or virtual networking, worldwide cable-free networking in SimonsVoss WaveNet or a combination with existing SimonsVoss systems.

All versions of the renowned MIFARE® Classic ID card and cards based on MIFARE Plus® or MIFARE® DESFire® technology can be read. The new cylinder is no bigger than a conventional digital locking cylinder and is powered in the same way using standard button cells.

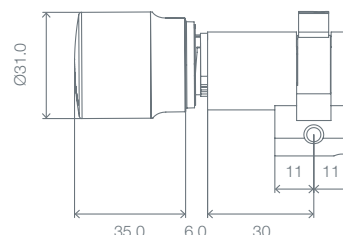

Measurements indicated in mm

TECHNICAL SPECIFICATIONS

- ⌘ Digital Swiss Round Half Cylinder – SC
- ⌘ Thumb-turn diameter: 31 mm
- ⌘ Basic installation length: 30-10 mm (external/inside dimension)
- ⌘ Overall length: up to 100 mm (max. 90 mm on one side); special lengths on request
- ⌘ Protection rating: IP54; .WP version: IP66
- ⌘ Battery type: 2 x lithium, CR2450, 3 V
- ⌘ Battery life: up to 65,000 lock operations* or up to six years on standby
- ⌘ Temperature range: Operational: -25 °C +65 °C
- ⌘ Audible feedback signal from a buzzer
- ⌘ Visual feedback signal from blue/red LED
- ⌘ Buzzer and blue/red LED indicate Battery Warning Levels 1 and 2; locks are only activated after delays of varying length
- ⌘ 3,000 access events can be saved
- ⌘ 100 time zone groups
- ⌘ Up to 64,000 smart cards can be managed per locking device (depending on the locking system configuration)
- ⌘ Up to 32,000 locking devices can be managed per smart card (depending on available memory on the smart card and the locking system configuration)
- ⌘ Can be directly networked with integrated Lock Node (Network Thumb-turn Cover WNM.LN.I.MP)
- ⌘ Freely configurable

*Up to 35,000 lock operations with access logging on the smart card

DIGITAL SWISS ROUND
HALF CYLINDER
3061 – SC

PRODUCT VERSIONS

Digital Swiss Round Half Cylinder 3061 – SC with G2 functions

Installation length 30-10 mm; thumb-turn detachable, stainless steel design, internal power supply; can be operated from outside with smart cards/smart tags featuring MIFARE®Classic, MIFARE Plus® and MIFARE® DESFire® technology; no cabling necessary

Z4.SR.30-10.MP.HZ.G2

Brass design

.MS

Version with access control, time zone management and events logging

.ZK

Multi-point version

.MR

Weatherproof version, protection rating IP66

.WP

'Network Inside' version with integrated Lock Node

WNM.LN.I.MP

INSTALLATION LENGTHS (all length specifications: external - inside):

Overall length from 45 mm to 70 mm

e.g. Z4.SR.60-10.MP.HZ.G2

Overall length over 80 mm to 100 mm

e.g. Z4.SR.80-10.MP.HZ.G2

Overall length over 100 mm

on request

DIGITAL BRITISH OVAL DOUBLE THUMB-TURN CYLINDER 3061 – SC – COMFORT

G2

Digital Locking Cylinder – SC with an enclosed electronics assembly as per DIN EN 15684 / EN 1303 for fitting into doors with a British oval profile:

- ⌘ Inner side is permanently engaged
- ⌘ MIFARE® Classic, Plus® and DESFire®
- ⌘ Optional access control, events logging and time zone management
- ⌘ Versions with protection rating IP66
- ⌘ Upgrade for direct networking

The options are endless whether you use direct or virtual networking, worldwide cable-free networking in SimonsVoss WaveNet or a combination with existing SimonsVoss systems.

All versions of the renowned MIFARE® Classic ID card and cards based on MIFARE Plus® or MIFARE® DESFire® technology can be read. The new cylinder is no bigger than a conventional digital locking cylinder and is powered in the same way using standard button cells.

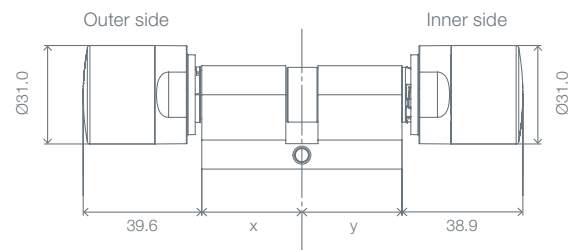

Measurements indicated in mm

TECHNICAL SPECIFICATIONS

- ⌘ Digital British Oval Profile Cylinder
- ⌘ Thumb-turn diameter: 31 mm
- ⌘ Basic installation length: 30–30 mm (external/inside dimension)
- ⌘ Overall length: up to 140 mm (max. 90 mm on one side); special lengths on request
- ⌘ Protection rating: IP54; .WP version: IP66
- ⌘ Battery type: 2 x lithium, CR2450, 3 V
- ⌘ Battery life: up to 65,000 lock operations* or up to six years on standby
- ⌘ Temperature range: Operational: -25 °C +65 °C
- ⌘ Audible feedback signal from a buzzer
- ⌘ Visual feedback signal from blue/red LED
- ⌘ Buzzer and blue/red LED indicate Battery Warning Levels 1 and 2; locks are only activated after delays of varying length
- ⌘ 3,000 access events can be saved
- ⌘ 100 time zone groups
- ⌘ Up to 64,000 smart cards can be managed per locking device (depending on the locking system configuration)
- ⌘ Up to 32,000 locking devices can be managed per smart card (depending on available memory on the smart card and the locking system configuration)
- ⌘ Can be directly networked with integrated Lock Node (Network Cover WNM.LN.I.MP)
- ⌘ Freely configurable

*Up to 35,000 lock operations with access logging on the smart card

DIGITAL BRITISH OVAL
DOUBLE THUMB-TURN CYLINDER
3061 – SC – COMFORT

PRODUCT VERSIONS

| | |
|---|---------------------------|
| Digital British Oval Double Thumb-turn Cylinder 3061 – SC – Comfort with G2 functions Installation length 30-30 mm, stainless steel design, comfort cylinder, internal power supply, rotary thumb-turn on both sides; can be operated on the inside and outside with smart cards/smart tags featuring MIFARE®Classic, MIFARE Plus® and MIFARE® DESFire® technology; no cabling necessary | Z4.BO.30-30.MP.CO.G2 |
| Brass design | .MS |
| Version with access control, time zone management and events logging | .ZK |
| Weatherproof version, protection rating IP66 | .WP |
| 'Network Inside' version with integrated Lock Node | WNM.LN.I.MP |
| INSTALLATION LENGTHS (all length specifications: external - inside): | |
| Overall length from 65 mm to 80 mm | e.g. Z4.BO.40-40.MP.CO.G2 |
| Overall length over 80 mm to 100 mm | e.g. Z4.BO.40-60.MP.CO.G2 |
| Overall length over 100 mm up to max. 140 mm (max. 90 mm on one side) | e.g. Z4.BO.65-75.MP.CO.G2 |
| Overall length over 140 mm or over 90 mm on one side | on request |

DIGITAL BRITISH OVAL DOUBLE THUMB-TURN CYLINDER 3061 – SC – FD

G2

Digital Locking Cylinder – SC with an enclosed electronics assembly as per DIN EN 15684 / EN 1303 for fitting into doors with a British oval profile:

- ⌘ Freely rotating on both sides – Reader inside and outside
- ⌘ MIFARE® Classic, Plus® and DESFire®
- ⌘ Optional access control, events logging and time zone management
- ⌘ Versions with protection rating IP66
- ⌘ Upgrade for direct networking

The options are endless whether you use direct or virtual networking, worldwide cable-free networking in SimonsVoss WaveNet or a combination with existing SimonsVoss systems.

All versions of the renowned MIFARE® Classic ID card and cards based on MIFARE Plus® or MIFARE® DESFire® technology can be read. The new cylinder is no bigger than a conventional digital locking cylinder and is powered in the same way using standard button cells.

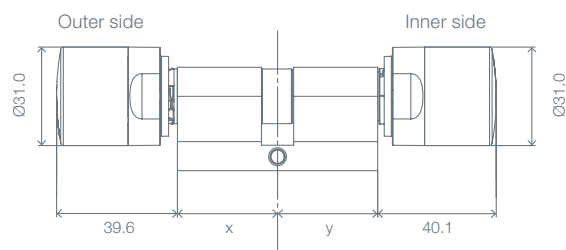

Measurements indicated in mm

TECHNICAL SPECIFICATIONS

- ⌘ Digital British Oval Cylinder, stainless steel design, freely rotating on both sides
- ⌘ Thumb-turn diameter: 31 mm
- ⌘ Basic installation length: 30–30 mm (external/inside dimension)
- ⌘ Overall length: up to max. 140 mm (outside max. 90 mm); special lengths on request
- ⌘ Protection rating: IP54; .WP version (electronic thumb-turn): IP66
- ⌘ Battery type: 4 x lithium, CR2450, 3 V
- ⌘ Battery life: up to 65,000 lock operations* or up to six years on standby
- ⌘ Temperature range: Operational: -25 °C +65 °C
- ⌘ Audible feedback signal from a buzzer
- ⌘ Visual feedback signal from blue/red LED
- ⌘ Buzzer and blue/red LED indicate Battery Warning Levels 1 and 2; locks are only activated after delays of varying length
- ⌘ 3,000 access events can be saved
- ⌘ 100 time zone groups*
- ⌘ Up to 64,000 smart cards can be managed per locking device (depending on the locking system configuration)
- ⌘ Up to 32,000 locking devices can be managed per smart card (depending on available memory on the smart card and the locking system configuration)
- ⌘ Can be directly networked with integrated Lock Node (Network Cover WNM.LN.I.MP)
- ⌘ Freely configurable

*Up to 35,000 lock operations with access logging on the smart card

DIGITAL BRITISH OVAL
DOUBLE THUMB-TURN CYLINDER
3061 – SC – FD

PRODUCT VERSIONS

| | |
|---|----------------------|
| Digital British Oval Double Thumb-turn Cylinder 3061 – SC – FD with G2 functions Installation length 30-30 mm, stainless steel design, internal power supply; can be operated from inside and outside with smart cards/smart tags featuring MIFARE®Classic, MIFARE Plus® and MIFARE® DESFire® technology; no cabling necessary | Z4.BO.30-30.MP.FD.G2 |
| Brass design | .MS |
| Version with access control, time zone management and events logging | .ZK |
| Weatherproof version, protection rating IP66 | .WP |
| 'Network Inside' version with integrated Lock Node | WNM.LN.I.MP |

INSTALLATION LENGTHS (all length specifications: external - inside):

| | |
|---|---------------------------|
| Overall length from 65 mm to 80 mm | e.g. Z4.BO.40-40.MP.FD.G2 |
| Overall length over 80 mm to 100 mm | e.g. Z4.BO.40-60.MP.FD.G2 |
| Overall length over 100 mm up to max. 140 mm (max. 90 mm on one side) | e.g. Z4.BO.65-75.MP.FD.G2 |
| Overall length over 140 mm or over 90 mm on one side | on request |

CONFIGURATION DIGITAL LOCKING CYLINDERS – SC

G2

COMBINATIONS WITH DIGITAL EURO PROFILE DOUBLE THUMB-TURN CYLINDER 3061 – SC – COMFORT DOUBLE THUMB-TURN CYLINDER 3061 – SC – FD

| | DM | MS | ZK | MR | WP | WNM |
|-------|----|----|----|----|----|-----|
| MP FD | ● | ○ | ● | ● | ● | ● |
| MP CO | X | ○ | ● | X | ● | ● |
| DM | | ○ | ● | X | ● | ● |
| MS | | | ○ | ○ | ○ | ○ |
| ZK | | | | ● | ● | ● |
| MR | | | | | ● | ● |
| WP | | | | | | ● |

- KEY:
- AP/ AP2 Anti-panic
 - BL Reader on both sides
 - BO British oval
 - DK Detachable thumb-turn
 - FD Freely rotating
 - FH Fire-retardant version
 - HZ Half cylinder
 - MP SC cylinder
 - MR Multi-point version
 - MS Brass design
 - OK Without inside thumb-turn
 - RS Scandinavian round
 - SKG VdS Approval Class AZ, SKG Approval SKG***
 - SO Scandinavian oval
 - SR Swiss round
 - SW Seawater-proof version
 - TS Button control
 - VdS VdS design
 - VR Shortened range
 - WNM Network Inside – network-ready online
 - WP Weatherproof version
 - ZK Access control, time zone management and events logging.

DIGITAL EURO PROFILE DOUBLE THUMB-TURN CYLINDER 3061 – SC – ANTI-PANIC

| | MS | ZK | WP | WNM |
|--------|----|----|----|-----|
| AP2 FD | ○ | ● | ● | ● |
| AP2 BL | ○ | ● | ● | ● |
| AP2 CO | ○ | ● | ● | ● |
| MS | | ○ | ○ | ○ |
| ZK | | | ● | ● |
| WP | | | | ● |

COMBINATIONS WITH DIGITAL EURO PROFILE HALF CYLINDER 3061 – SC

| | MS | ZK | WP | DK | WNM |
|----|----|----|----|----|-----|
| HZ | ○ | ● | ● | ● | ● |
| MS | | ○ | ○ | ○ | ○ |
| ZK | | | ● | ● | ● |
| WP | | | | ● | ● |
| DK | | | | | ● |

CONFIGURATION
DIGITAL LOCKING CYLINDER –
SC

G2

COMBINATIONS WITH DIGITAL SCANDINAVIAN
OVAL CYLINDER 3061 – SC
ROUND CYLINDER 3061 – SC

| | MS | ZK | WP | WNM |
|------|----|----|----|-----|
| SO.A | ○ | ● | ● | ● |
| RS.A | ○ | ● | ● | ● |
| MS | | ○ | ○ | ○ |
| ZK | | | ● | ● |
| WP | | | | ● |

COMBINATIONS WITH DIGITAL BRITISH OVAL
DOUBLE THUMB-TURN CYLINDER 3061 – SC –
COMFORT
DOUBLE THUMB-TURN CYLINDER 3061 – SC – FD

| | MS | ZK | WP | WNM |
|-------|----|----|----|-----|
| BO FD | ○ | ● | ● | ● |
| BO CO | ○ | ● | ● | ● |
| MS | | ○ | ○ | ○ |
| ZK | | | ● | ● |
| WP | | | | ● |

COMBINATIONS WITH DIGITAL SWISS ROUND
DOUBLE THUMB-TURN CYLINDER 3061 – SC

| | MS | ZK | WP | WNM |
|-------|----|----|----|-----|
| SR CO | ○ | ● | ● | ● |
| MS | | ○ | ○ | ○ |
| ZK | | | ● | ● |
| WP | | | | ● |

COMBINATIONS WITH DIGITAL SWISS ROUND
HALF CYLINDER 3061 – SC

| | MS | ZK | WP | WNM |
|-------|----|----|----|-----|
| SR HZ | ○ | ● | ● | ● |
| MS | | ○ | ○ | ○ |
| ZK | | | ● | ● |
| WP | | | | ● |

PASSIVE SMART CARD TECHNOLOGY
DIGITAL LOCKING CYLINDER
3061 – HYBRID



DIGITAL EURO PROFILE DOUBLE THUMB-TURN CYLINDER 3061 – HYBRID

G2

Digital Locking Cylinder – Hybrid with an enclosed electronics assembly as per DIN 18252 / DIN EN 15684 / EN 1303 for fitting into Euro profile locks as per DIN 18251. Approval for fitting into locks as per DIN 18250 (fire protection).

- ⚡ Can be operated with transponders and MIFARE® cards
- ⚡ MIFARE® Classic and DESFire®
- ⚡ Freely rotating on both sides – Reader inside and outside
- ⚡ Access control, time zone management and events logging
- ⚡ Versions with protection rating IP66
- ⚡ Upgrade for direct networking

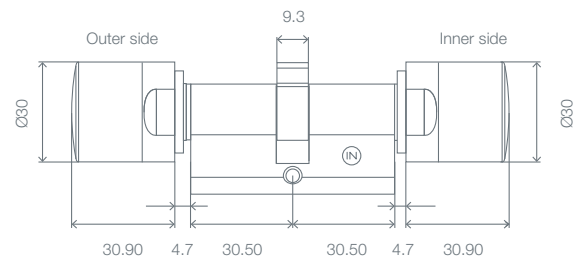

Measurements indicated in mm

The options are endless whether you use direct or virtual networking, active or passive cards, worldwide cable-free networking in SimonsVoss WaveNet or a combination with existing SimonsVoss systems.

All versions of the renowned MIFARE® Classic ID card and cards based on the more recent MIFARE® DESFire® technology can be read. The new cylinder is no bigger than a conventional digital locking cylinder and is powered in the same way using standard button cells.

TECHNICAL SPECIFICATIONS

- ⚡ Standard Euro Profile cylinder as per DIN 18252 / EN 1303 / DIN EN 15684
- ⚡ Thumb-turn diameter: 30 mm
- ⚡ Basic installation length: 30–30 mm (external/inside dimension)
- ⚡ Overall length: up to 140 mm (max. 90 mm on one side); special lengths on request
- ⚡ Protection rating: IP54; .WP version: IP66
- ⚡ Battery type: 4 x lithium, CR2450, 3 V
- ⚡ Battery life: up to 130,000 lock operations or up to ten years on standby
- ⚡ Temperature range: Operational: -25 °C to +65 °C
- ⚡ Audible feedback signal from buzzer
- ⚡ Visual feedback signal from blue/red LED (only when activated using a smart card)

- ⚡ Buzzer and blue/red LED indicate Battery Warning Levels 1 and 2; locks are only activated after delays of varying length
- ⚡ 3,000 access events can be saved
- ⚡ 100 time zone groups
- ⚡ Up to 64,000 transponders can be managed per locking device
- ⚡ Up to 64,000 smart cards can be managed per locking device (depending on the locking system configuration)
- ⚡ Up to 304,000 locking devices can be managed per transponder
- ⚡ Up to 32,000 locking devices can be managed per smart card (depending on available memory on the smart card and the locking system configuration)
- ⚡ Network-ready directly with integrated Lock Node (Network Thumb-turn Cover WNM.LN.I)
- ⚡ Can be freely configured

*Up to 60,000 lock operations with access logging on the smart card

DIGITAL EURO PROFILE
DOUBLE THUMB-TURN CYLINDER
3061 – HYBRID

PRODUCT VERSIONS

| | |
|---|------------------------|
| <p>Digital Euro Profile Double Thumb-turn Cylinder 3061 – Hybrid with G2 functions Freely rotating digital locking cylinder, installation length 30-30 mm, stainless steel design, dimensions as per DIN 18252, internal power supply, rotary thumb-turn on both sides; can be operated with transponders from inside and outside; on the outside, the cylinder can also read smart cards/smart tags featuring MIFARE® Classic and MIFARE® DESFire® technology; no cabling necessary;</p> | Z4.30-30.MH.FD.G2 |
| Brass design | .MS |
| Version with access control, time zone management and events logging | .ZK |
| Version with button control (can be operated from inside without transponder) | .TS |
| <p>Multi-point version For use in doors with multi-point locks, from installation length 35-30 mm</p> | .MR |
| <p>Fire-retardant version For use in steel and fire doors</p> | .FH |
| <p>Weatherproof version, protection rating IP66 (electronic thumb-turn), not available in combination with .TS or .MR</p> | .WP |
| 'Network Inside' version with integrated Lock Node | WNM.LN.I |
| <p>INSTALLATION LENGTHS (all length specifications: external - inside):</p> | |
| Overall length from 65 mm to 80 mm | e.g. Z4.40-40.MH.FD.G2 |
| Overall length over 80 mm to 100 mm | e.g. Z4.40-60.MH.FD.G2 |
| Overall length over 100 mm up to max. 140 mm (max. 90 mm on one side) | e.g. Z4.65-75.MH.FD.G2 |
| Overall length over 140 mm or over 90 mm on one side | on request |

DIGITAL BRITISH OVAL DOUBLE THUMB-TURN CYLINDER 3061 – HYBRID

G2

Hybrid digital locking cylinder with an enclosed electronics assembly as per DIN EN 15684 / EN 1303 for fitting into doors with a British oval profile. Approval for fitting into locks as per DIN 18250 (fire protection).

- ⌘ Can be operated with transponders and MIFARE® cards
- ⌘ MIFARE® Classic and DESFire®
- ⌘ Freely rotating on both sides – Reader inside and outside
- ⌘ Access control, time zone management and events logging
- ⌘ Versions with protection rating IP66
- ⌘ Upgrade for direct networking

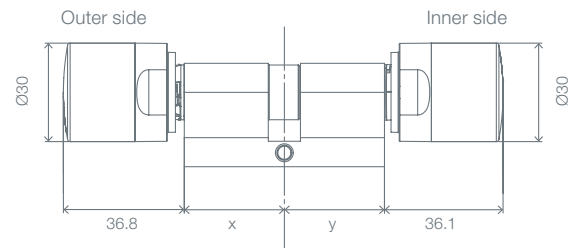

Measurements indicated in mm

TECHNICAL SPECIFICATIONS

- ⌘ British Oval Profile Cylinder
- ⌘ Thumb-turn diameter: 30 mm
- ⌘ Basic installation length: 30–30 mm (external/inside dimension)
- ⌘ Overall length: up to max. 140 mm (outside max. 90 mm); special lengths on request
- ⌘ Protection rating: IP54; .WP version: IP66
- ⌘ Battery type: 4 x lithium, CR2450, 3 V
- ⌘ Battery life: up to 130,000 lock operations or up to ten years on standby
- ⌘ Temperature range: Operational: -25 °C to +65 °C
- ⌘ Audible feedback signal from buzzer
- ⌘ Visual feedback signal from blue/red LED (only when activated using a smart card)
- ⌘ Buzzer and blue/red LED indicate Battery Warning Levels 1 and 2, locks are only activated after delays of varying length
- ⌘ 3,000 access events can be saved
- ⌘ 100 time zone groups*
- ⌘ Up to 64,000 transponders can be managed per locking device
- ⌘ Up to 64,000 smart cards can be managed per locking device (depending on the locking system configuration)

- ⌘ Up to 304,000 lock devices can be managed per transponder
- ⌘ Up to 32,000 locks can be managed per smart card (depending on available memory on the smart card and the locking system configuration)
- ⌘ Can be directly networked with integrated Lock Node (Network Thumb-turn Cover WNM.LN.I)
- ⌘ Can be freely configured

*Up to 60,000 lock operations with access logging on the smart card

DIGITAL BRITISH OVAL
DOUBLE THUMB-TURN CYLINDER
3061 – HYBRID

PRODUCT VERSIONS

| | |
|---|---------------------------|
| Digital British Oval Double Thumb-turn Cylinder 3061 – Hybrid with G2 functions Installation length 30-30 mm, stainless steel design, internal power supply, rotary thumb-turn on both sides; can be operated with transponders from inside and outside; on the outside, the cylinder can also be operated with smart cards/smart tags featuring MIFARE® Classic and MIFARE® DESFire® technology; no cabling necessary | Z4.BO.30-30.MH.FD.G2 |
| Brass design | .MS |
| Version with access control, time zone management and events logging | .ZK |
| Version with button control (can be operated from inside without transponder) | .TS |
| Multi-point version For use in doors with multi-point locks, from installation length 35-30 mm | .MR |
| Fire-retardant version For use in steel and fire doors | .FH |
| Weatherproof version, protection rating IP66 (electronic thumb-turn), not available in combination with .TS or .MR | .WP |
| 'Network Inside' version with integrated Lock Node | WNM.LN.I |
| INSTALLATION LENGTHS (all length specifications: external - inside): | |
| Overall length from 65 mm to 80 mm | e.g. Z4.BO.40-40.MH.FD.G2 |
| Overall length over 80 mm to 100 mm | e.g. Z4.BO.40-60.MH.FD.G2 |
| Overall length over 100 mm up to max. 140 mm (max. 90 mm on one side) | e.g. Z4.BO.65-75.MH.FD.G2 |
| Overall length over 140 mm or over 90 mm on one side | on request |

CONFIGURATION DIGITAL LOCKING CYLINDERS – HYBRID

G2

COMBINATIONS WITH DIGITAL EURO PROFILE DOUBLE THUMB-TURN CYLINDER 3061 – HYBRID

| | ZK | MR | FH | WP | VDS | WNM |
|-----------|----|----|----|----|-----|-----|
| Hybrid FD | ● | ● | ● | ● | ● | ● |
| ZK | | ● | ● | ● | ● | ● |
| MR | | | ● | ● | ● | ● |
| FH | | | | ● | ● | ● |
| WP | | | | | ● | ● |
| VDS | | | | | | ● |

COMBINATIONS WITH DIGITAL BRITISH OVAL DOUBLE THUMB-TURN CYLINDER 3061 – HYBRID

| | ZK | TS | FH | WP | WNM |
|-----------|----|----|----|----|-----|
| Hybrid FD | ● | ● | ● | ● | ● |
| ZK | | ● | ● | ● | ● |
| TS | | | ● | X | ● |
| FH | | | | ● | ● |
| WP | | | | | ● |

KEY:

- AP/ AP2 Anti-panic
- BL Reader on both sides
- BO British oval
- DK Detachable thumb-turn
- FD Freely rotating
- FH Fire-retardant version
- HZ Half cylinder
- MP SC cylinder
- MR Multi-point version
- MS Brass design
- OK Without inside thumb-turn
- RS Scandinavian round
- SKG VdS Approval Class AZ, SKG Approval SKG***
- SO Scandinavian oval
- SR Swiss round
- SW Seawater-proof version
- TS Button control
- VDS VdS design
- VR Shortened range
- WNM Network Inside – network-ready online
- WP Weatherproof version
- ZK Access control, time zone management and events logging.

THUMB-TURNS & ACCESSORIES

DIGITAL LOCKING CYLINDER 3061 – SC AND HYBRID

PRODUCT VERSIONS

THUMB-TURNS FOR HYBRID CYLINDERS

Thumb-turn for electronic side of heavy-duty doors,
diameter 35 mm, plastic, only suitable for FD/BO.FD

Z4.KNAUF3

TN4 cover for electronic side of the cylinder

Z4.KAPPE1

ACCESSORIES FOR SMART CARD AND HYBRID CYLINDERS

Installation/battery key: special tool for installing/disassembling and for replacing batteries (button cells)

Z4.SCHLUESSEL

10 batteries (type: CR2450)

Z4.BAT.SET

PASSIVE SMART CARD TECHNOLOGY

DIGITAL SMART HANDLES

3062 – SC



DIGITAL SMART HANDLE 3062 – SC

COMPOSITION OF ITEM CODE WITH EXAMPLE:

Identifier for electronic door handle = SH

Profile: **A = Euro Profile/Swiss Round/British Oval**

- B = Scandinavian Oval
- C = Euro Profile with Mechanical Override (MO)
- D = Swiss Round with MO
- E = Scandinavian Oval with MO

Profile/door thickness: **S = 39-60 mm or 33-54 mm for SO, 30-51 for SO.DP**

- (an additional adapter is required for British Oval)
- M = 59-80 mm or 53-74 mm for SO, 50-71 mm for SO.DP
- L = 79-100 mm or 73-94 mm for SO, 70-91 mm for SO.DP

Spindle: 07 = 7 mm

- 08 = 8 mm
- F8 = 8 mm (fire retardant doors)
- F8 = 9 mm (fire retardant doors)
- 10 = 10 mm** (with adapter sleeve)
- 8.5 mm (through sleeve SH.HUELSE.8.5; see under Accessories)

Fastening type / plate width: A = snap-in, narrow (41 mm)

B = snap-in, wide (53 mm)

- C = conventional fastening, narrow (41 mm)
- D = conventional fastening, wide (53 mm)
- E = conventional fastening MO – inside and outside cut-out, narrow (41 mm)
- F = conventional fastening MO – inside and outside cut-out – wide (53 mm)
- G = conventional fastening MO – inside blank/outside cut-out, narrow (41 mm)
- H = conventional fastening MO – inside blank/outside cut-out, wide (53 mm)
- I = conventional fastening MO – inside cut-out/outside blank, narrow (41 mm)
- J = conventional fastening MO – inside cut-out/outside blank, wide (53 mm)
- K = conventional fastening MO – inside and outside blank, narrow (41 mm)
- L = conventional fastening MO – inside and outside blank, wide (53 mm)

Centres distance: 00 = conventional fastening system

- 70 = 70 mm
- 72 = 72 mm
- 74 = 74 mm (for Swiss Round only)
- 75 = 75 mm
- 78 = 78 mm
- 85 = 85 mm**
- 88 = 88 mm
- 90 = 90 mm
- 92 = 92 mm
- 94 = 94 mm (for Swiss Round only)
- 96 = 96 mm (for Scandinavian Oval only)
- 05 = 105 mm (for Scandinavian Oval only)

Version: 0 = engaged (without electronics, not for Scandinavian Oval)

1 = engaged for use on one side

Handle versions, outside: **A = L-shaped R (rounded, curved)**

- B = L-shaped G (mitred)
- C = U-shaped R (rounded, curved)
- D = U-shaped G (mitred)
- E = U-shaped R (rounded, curved), offset
- F = U-shaped G (mitred), offset

Handle versions inside: **A = L-shaped R (rounded, curved)**

- B = L-shaped G (mitred)
- C = U-shaped R (rounded, curved)
- D = U-shaped G (mitred)
- E = U-shaped R (rounded, curved), offset
- F = U-shaped G (mitred), offset

Surface finish: **1 = brushed stainless steel**

3 = brass

Reader technology: 0 = without electronics

- 1 = active
- 2 = hybrid

3 = MIFARE® Pure

Options: **G2, ZK, WP, DP** (for SO only)

| | | | | | | | | | | |
|----|----|----|---|----|---|---|---|---|---|----|
| SH | AS | 10 | B | 85 | 1 | A | A | 1 | 3 | G2 |
|----|----|----|---|----|---|---|---|---|---|----|

Item code for the aforementioned example: SHAS10B851AA13G2

DIGITAL SMART HANDLE 3062 – SC

G2

This SimonsVoss electronic door handle combines intelligent access control functions with an elegant, ergonomic design. Behind its slim, flat exterior lies highly innovative technology.

In developing the new SmartHandle 3062 door fitting, we focussed particularly on usage requirements in the healthcare and care home sectors. SmartHandle can be used with doors fitted with Euro Profile cylinders, Swiss Round, British Oval and Scandinavian Oval mortise locks.

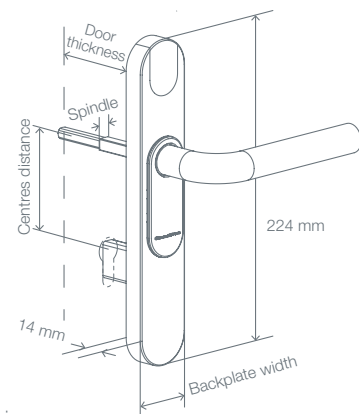

Measurements indicated in mm

UNIQUE SELLING POINT

The innovative snap-in fitting system means that there is no need to drill holes in doors, thus ensuring existing doors are not damaged and installation times are greatly reduced.

SYSTEM SPECIFICATIONS AND INTERDEPENDENCIES WITH OTHER PRODUCTS

LSM 3.1 or higher, Programming Device Smart CD.HF.

TECHNICAL SPECIFICATIONS (CAN ONLY BE SUPPLIED IN CONJUNCTION WITH G2)

- ⚡ Types: Euro Profile cylinder (as per DIN 18252 / EN1303), British Oval (snap-in adapter required), Swiss Round, Scandinavian Oval
- ⚡ Dimensions (W x H x D):
Narrow: 41 x 224 x 14 mm
Wide: 53 x 224 x 14 mm
- ⚡ Dimensions SO (W x H x D):
Narrow: 48 x 230.2 x 21.75 mm
Wide: 59 x 229.2 x 21.75 mm
- ⚡ Reader type:
MIFARE® Classic, MIFARE® DESFire®, MIFARE Plus®
- ⚡ Battery type: 2x CR2450, 3 V, lithium.
- ⚡ Battery life: up to 65,000 operations or up to 6 years on stand-by
- ⚡ Temperature range: operational: -20 °C to +50 °C
- ⚡ In storage (temporary): -40 °C to +70 °C
In storage (long-term): 0 °C to +30 °C
- ⚡ Feedback signal: audible (buzzer) and visual (LED – blue/red)
- ⚡ Storable access events: up to 3,000
- ⚡ Time zone groups: 100+1
- ⚡ Number of media (transponders/SmartCards) which can be managed per cylinder: up to 64,000 (depends on the chosen configuration/template)
- ⚡ Number of locking operations that can be managed per locking cylinder: up to 32,000 (depends on the chosen configuration/template)
- ⚡ Different permanent/open modes
- ⚡ Networking capability: network-ready with integrated LockNode; can be retrofit at any time
- ⚡ Upgradability: firmware upgradable
- ⚡ Other: freely configurable

DIGITAL SMART HANDLE 3062 – SC

G2



Digital SmartHandle is available with three different types of fastening:
Snap-in, conventional fastening or conventional fastening with mechanical override (MO).

BASIC VERSIONS.

| Description | Order code |
|--|--|
| DIGITAL SMARTHANDLE 3062 – SC | |
| Digital SmartHandle 3062 – SC – Snap-in with G2 Functions Electronic door handle for mounting on doors, equipped with a handle lock for Euro Profile, Swiss Round or British Oval; outer side can be operated with MIFARE® SmartCards/SmartTags; inside is always engaged ready for use. | SHA*...A**3G2*** SHA*...B**3G2*** |
| Digital SmartHandle 3062 – SC – Conventional Fastening with G2 Functions Electronic door handle for conventional mounting with screws, equipped with a handle lock for Euro Profile, Swiss Round or British Oval; outer side can be operated with MIFARE® SmartCards/SmartTags; inside is always engaged ready for use. | SHA*...C**3G2*** SHA*...D**3G2*** |
| Digital SmartHandle 3062 – SC – Conventional Fastening with MO and G2 Functions for Euro Profile Electronic door handle conventional mounting with screws, with handle lock designed for Euro Profile; outer side can be operated with MIFARE® SmartCards/SmartTags; inside is always engaged ready for use. | SHC*...E-L**3G2*** |
| Digital SmartHandle 3062 – SC – Conventional Fastening with MO and G2 Functions for Swiss Round Electronic door handle conventional mounting with screws, with handle lock designed for Swiss Round; outer side can be operated with MIFARE® SmartCards/SmartTags; inside is always engaged ready for use. | SHD*...E-L**3G2*** |

* Identifiers for profile:

A = Euro Profile/Swiss Round/British Oval
C = Euro Profile with mechanical override
D = Swiss Round with mechanical override

** Identifiers for fastening system/backplate width:

A = snap-in, narrow
B = snap-in, wide
C = conventional fastening, narrow
D = conventional fastening, wide
E-L = versions for mechanical override

*** Identifiers for reader technology/option:

3 = MIFARE® Pure
G2 = with G2 functions

DIGITAL
SMART HANDLE 3062 – SC

OPTIONS

| Description | Order code |
|--|------------|
| PROFILE | |
| Euro Profile / Swiss Round / British Oval* | A |
| Euro Profile with mechanical override (MO) | C |
| Swiss Round with mechanical override (MO) | D |
| DOOR THICKNESS | |
| 39 – 60 mm | S |
| 59 – 80 mm | M |
| 79 – 100 mm | L |
| SPINDLE | |
| 7 mm | 07 |
| 8 mm | 08 |
| 8 mm (fire retardant doors) | F8 |
| 9 mm (fire retardant doors) | 09 |
| 10 mm (with adapter sleeve) | 10 |
| FASTENING SYSTEM/PLATE WIDTH | |
| Snap-in plate (41 mm) | A |
| Snap-in plate (53 mm) | B |
| Conventional fastening, narrow (41 mm) | C |
| Conventional fastening, wide (53 mm) | D |
| MO cut-out inside and outside, narrow (41 mm) | E |
| MO inside and outside cut-out, wide (53 mm) | F |
| MO inside blank, cut-out outside, narrow (41 mm) | G |
| MO inside blank, cut-out outside, wide (53 mm) | H |
| MO inside cut-out, outside blank, narrow (41 mm) | I |
| MO inside cut-out, outside blank, wide (53 mm) | J |
| MO inside and outside blank, narrow (41 mm) | K |
| MO inside and outside blank, wide (53 mm) | L |

*Adapter sleeve required (see Accessories)

DIGITAL
SMART HANDLE 3062 – SC

| Description | Order code |
|---|------------|
| CENTRES DISTANCE | |
| Conventional fastening | 00 |
| 70 mm (for snap-in only) | 70 |
| 72 mm (for Snap-in and Mechanical Override only) | 72 |
| 74 mm (for Swiss Round – Snap-in and Mechanical Override only) | 74 |
| 75 mm (for Snap-in and Mechanical Override only) | 75 |
| 78 mm (for Snap-in and Mechanical Override only) | 78 |
| 85 mm (for Snap-in and Mechanical Override only) | 85 |
| 88 mm (for Snap-in and Mechanical Override only) | 88 |
| 92 mm (for Snap-in and Mechanical Override only) | 92 |
| 94 mm (for Swiss Round – Snap-in and Mechanical Override only) | 94 |
| VERSION | |
| Engaged (for SmartHandle without electronics only) | 0 |
| Engages for use on one side (for all SmartHandles with electronics) | 1 |
| HANDLE VERSION, OUTSIDE | |
| L-shaped R (rounded) | A |
| L-shaped G (mitred) | B |
| U-shaped R (rounded) | C |
| U-shaped G (mitred) | D |
| U-shaped R (rounded), offset | E |
| U-shaped G (mitred), offset | F |
| HANDLE VERSION, INSIDE | |
| L-shaped R (rounded) | A |
| L-shaped G (mitred) | B |
| U-shaped R (rounded) | C |
| U-shaped G (mitred) | D |
| U-shaped R (rounded), offset | E |
| U-shaped G (mitred), offset | F |

DIGITAL
SMART HANDLE 3062 – SC

| Description | Order code |
|--|---------------|
| SURFACE | |
| Stainless steel, brushed | 1 |
| Brass version | 3 |
| READER TECHNOLOGY | |
| MIFARE® Pure | 3 |
| OPTIONS | |
| With G2 functions | G2 |
| Version with access control, time zone control and logging | ZK |
| Weatherproof version | WP |
| ADAPTER | |
| Adapter for a handle lock designed to hold a British Oval profile | SH.BO.ADAPT |
| SPINDLE | |
| Sleeve from 8 mm to 8.5 mm (10 units) | SH.HUELSE.8.5 |
| Sleeve from 7 mm to 8 mm (10 units) | SH.HUELSE.7.8 |
| DIRECT NETWORKING | |
| 'Network Inside' version with integrated LockNode | WNM.LN.I.SH |
| DIRECT NETWORKING FOR DIGITAL SMART HANDLE | |
| You can find our order placement guide SmartHandle in the retailer section on our website www.simons-voss.com . | |

DIGITAL SMART HANDLE 3062 – SCANDINAVIAN OVAL – SC

G2



BASIC VERSIONS

| Description | Order code |
|--|-----------------|
| DIGITAL SMART HANDLE 3062 – SCANDINAVIAN OVAL – SC | |
| Digital SmartHandle 3062 – Scandinavian Oval – SC with G2 Functions Electronic door handle for mounting on doors, with handle lock designed for Scandinavian Oval; outer side can be operated with MIFARE® SmartCards/SmartTags; inner side is permanently engaged ready for use. | SHB*3G2** |
| Digital SmartHandle 3062 – Scandinavian Oval – SC with MO and G2 Functions Electronic door handle for mounting on doors; additional options for installing a mechanical cylinder as a secondary lock; with handle lock designed for Scandinavian Oval; outer side can be operated with MIFARE® SmartCards/SmartTags; inner side is permanently engaged ready for use. | SHE*3G2** |

OPTIONS

| Description | Order code |
|---|------------|
| PROFILE | |
| Scandinavian Oval | B |
| Scandinavian Oval with Mechanical Override (MO) | E |
| DOOR THICKNESS | |
| 33 – 54 mm | S |
| 53 – 74 mm | M |
| 73 – 94 mm | L |
| SPINDLE | |
| 7 mm | 07 |
| 8 mm | 08 |
| 8 mm (fire retardant doors) | F8 |
| 9 mm (fire retardant doors) | 09 |
| 10 mm (with adapter sleeve) | 10 |

* Identifiers for profile:

B = Scandinavian Oval

E = Scandinavian Oval with Mechanical Override

*** Identifier for reader technology/option:

3 = MIFARE® Pure

G2 = with G2 functions

DIGITAL
SMART HANDLE 3062 –
SCANDINAVIAN OVAL – SC

| Description | Order code |
|--|------------|
| FASTENING SYSTEM/PLATE WIDTH | |
| Conventional fastening, narrow (41 mm) | C |
| Conventional fastening, wide (53 mm) | D |
| MO cut-out inside and outside, narrow (41 mm) | E |
| MO inside and outside cut-out, wide (53 mm) | F |
| MO inside blank, cut-out outside, narrow (41 mm) | G |
| MO inside blank, cut-out outside, wide (53 mm) | H |
| MO inside cut-out, outside blank, narrow (41 mm) | I |
| MO inside cut-out, outside blank, wide (53 mm) | J |
| MO inside and outside blank, narrow (41 mm) | K |
| MO inside and outside blank, wide (53 mm) | L |
| CENTRES DISTANCE | |
| Adapter fastening | 00 |
| 96 mm (not for Mechanical Override) | 96 |
| 105 mm (for Mechanical Override only) | 05 |
| VERSION | |
| Engages for use on one side | 1 |
| HANDLE VERSION, OUTSIDE | |
| L-shaped R (rounded) | A |
| L-shaped G (mitred) | B |
| U-shaped R (rounded) | C |
| U-shaped G (mitred) | D |
| U-shaped R (rounded), offset | E |
| U-shaped G (mitred), offset | F |

DIGITAL
SMART HANDLE 3062 –
SCANDINAVIAN OVAL – SC

| Description | Order code |
|--|-------------|
| HANDLE VERSION, INSIDE | |
| L-shaped R (rounded) | A |
| L-shaped G (mitred) | B |
| U-shaped R (rounded) | C |
| U-shaped G (mitred) | D |
| U-shaped R (rounded), offset | E |
| U-shaped G (mitred), offset | F |
| SURFACE | |
| Stainless steel, brushed | 1 |
| Brass version | 3 |
| READER TECHNOLOGY | |
| MIFARE® Pure | 3 |
| OPTIONS | |
| With G2 functions | G2 |
| Version with access control, time zone control and logging | ZK |
| Weatherproof version | WP |
| 'Network Inside' version with integrated LockNode | WNM.LN.I.SH |
| DIRECT NETWORKING FOR DIGITAL SMART HANDLE | |
| You can find our order placement guide SmartHandle in the retailer section on our website www.simons-voss.com . | |

DIGITAL SMART HANDLE 3062 – HYBRID

COMPOSITION OF ITEM CODE WITH EXAMPLE:

Identifier for electronic door handle = SH

Profile: **A = Euro Profile/Swiss Round/British Oval**

- B = Scandinavian Oval
- C = Euro Profile with Mechanical Override (MO)
- D = Swiss Round with MO
- E = Scandinavian Oval with MO

Profile/door thickness: **S = 39-60 mm or 33-54 mm for SO, 30-51 for SO.DP**

- (an additional adapter is required for British Oval)
- M = 59-80 mm or 53-74 mm for SO, 50-71 mm for SO.DP
- L = 79-100 mm or 73-94 mm for SO, 70-91 mm for SO.DP

Spindle: 07 = 7 mm

- 08 = 8 mm
- F8 = 8 mm (fire retardant doors)
- F8 = 9 mm (fire retardant doors)
- 10 = 10 mm** (with adapter sleeve)
- 8.5 mm (through sleeve SH.HUELSE.8.5; see under Accessories)

Fastening type / plate width: A = snap-in, narrow (41 mm)

- B = snap-in, wide (53 mm)**
- C = conventional fastening, narrow (41 mm)
- D = conventional fastening, wide (53 mm)
- E = conventional fastening MO – inside and outside cut-out, narrow (41 mm)
- F = conventional fastening MO – inside and outside cut-out – wide (53 mm)
- G = conventional fastening MO – inside blank/outside cut-out, narrow (41 mm)
- H = conventional fastening MO – inside blank/outside cut-out, wide (53 mm)
- I = conventional fastening MO – inside cut-out/outside blank, narrow (41 mm)
- J = conventional fastening MO – inside cut-out/outside blank, wide (53 mm)
- K = conventional fastening MO – inside and outside blank, narrow (41 mm)
- L = conventional fastening MO – inside and outside blank, wide (53 mm)

Centres distance: 00 = conventional fastening system

- 70 = 70 mm
- 72 = 72 mm
- 74 = 74 mm (for Swiss Round only)
- 75 = 75 mm
- 78 = 78 mm
- 85 = 85 mm**
- 88 = 88 mm
- 90 = 90 mm
- 92 = 92 mm
- 94 = 94 mm (for Swiss Round only)
- 96 = 96 mm (for Scandinavian Oval only)
- 05 = 105 mm (for Scandinavian Oval only)

Version: 0 = engaged (without electronics, not for Scandinavian Oval)

1 = engaged for use on one side

Handle versions, outside: **A = L-shaped R (rounded, curved)**

- B = L-shaped G (mitred)
- C = U-shaped R (rounded, curved)
- D = U-shaped G (mitred)
- E = U-shaped R (rounded, curved), offset
- F = U-shaped G (mitred), offset

Handle versions inside: **A = L-shaped R (rounded, curved)**

- B = L-shaped G (mitred)
- C = U-shaped R (rounded, curved)
- D = U-shaped G (mitred)
- E = U-shaped R (rounded, curved), offset
- F = U-shaped G (mitred), offset

Surface finish: **1 = brushed stainless steel**

3 = brass

Reader technology: 0 = without electronics

- 1 = active
- 2 = hybrid**
- 3 = MIFARE® Pure

Options: **G2, ZK, WP, DP** (for SO only)

| | | | | | | | | | | |
|----|----|----|---|----|---|---|---|---|---|----|
| SH | AS | 10 | B | 85 | 1 | A | A | 1 | 2 | G2 |
|----|----|----|---|----|---|---|---|---|---|----|

Item code for the aforementioned example: SHAS10B851AA12G2

DIGITAL SMART HANDLE 3062 – HYBRID

G2

This SimonsVoss electronic door handle combines intelligent access control functions with an elegant, ergonomic design. Behind its slim, flat exterior lies highly innovative technology.

In developing the new SmartHandle 3062 door fitting, we focussed particularly on usage requirements in the healthcare and care home sectors. In addition to active technology, Smart Handle is also available in a Smart Card version and can be used with doors fitted with Euro Profile Cylinders, Swiss Round, British Oval and Scandinavian Oval mortise locks.

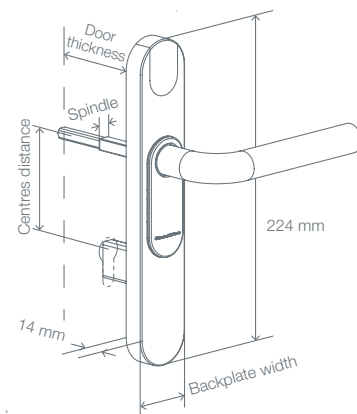

Measurements indicated in mm

UNIQUE SELLING POINT

The innovative snap-in fitting system means that there is no need to drill holes in doors, thus ensuring existing doors are not damaged and installation times are greatly reduced.

SYSTEM SPECIFICATIONS AND INTERDEPENDENCIES WITH OTHER PRODUCTS

LSM 3.1 or higher, Programming Device Smart CD.G2 and for the hybrid version, also Programming Device SmartCD.HF.

TECHNICAL SPECIFICATIONS (CAN ONLY BE SUPPLIED IN CONJUNCTION WITH G2)

- ⚙ Types: Euro Profile cylinder (as per DIN 18252 / EN1303), British Oval (snap-in adapter required), Swiss Round, Scandinavian Oval
- ⚙ Dimensions (W x H x D):
Narrow: 41 x 224 x 14 mm
Wide: 53 x 224 x 14 mm
- ⚙ Dimensions SO (W x H x D):
Narrow: 48 x 230.2 x 21.75 mm
Wide: 59 x 229.2 x 21.75 mm
- ⚙ Reader type:
active, MIFARE® Classic, MIFARE® DESFire®, MIFARE Plus®
- ⚙ Battery type: 4x CR2450, 3 V, Lithium.
- ⚙ Battery life: up to 120,000 operations or up to 10 years on stand-by
- ⚙ Temperature range: operational: -20 °C to +50 °C
- ⚙ In storage (temporary): -40 °C to +70 °C
In storage (long-term): 0 °C to +30 °C
- ⚙ Feedback signal: audible (buzzer) and visual (LED – blue/red)
- ⚙ Loggable access events: Up to 3,000
- ⚙ Time zone groups: 100+1
- ⚙ Number of media (transponders/SmartCards) which can be managed per cylinder:
Transponders: up to 64,000
(Number of smart cards depends on the chosen configuration/template)
- ⚙ Number of locking operations which can be managed per transponder/smart card:
up to 64,000 / 32,000
(depends on the chosen configuration/template)
- ⚙ Different permanent/open modes
- ⚙ Networking capability: network-ready with integrated LockNode; can be retrofit at any time
- ⚙ Upgradability: firmware upgradable
- ⚙ Other: freely configurable

DIGITAL SMART HANDLE 3062 – HYBRID

G2



Digital SmartHandle is available with three different types of fastening:
Snap-in, conventional fastening or conventional fastening with mechanical override (MO).

BASIC VERSIONS

| Description | Order code |
|---|--|
| DIGITAL SMARTHANDLE 3062 – HYBRID | |
| Digital SmartHandle 3062 – Hybrid – Snap-in with G2 Functions Electronic door handle for mounting on doors, with handle lock designed for Euro Profile, Swiss Round or British Oval; outer side can only be operated with SimonsVoss transponders and/or MIFARE® SmartCards/ SmartTags; inside is permanently engaged ready for use. | SHA*...A**2G2*** SHA*...B**2G2*** |
| Digital SmartHandle 3062 – Hybrid – Conventional Fastening with G2 Functions Electronic door handle for conventional fitting to doors with screws; with handle lock designed for Euro Profile, Swiss Round or British Oval; outer side can only be operated with SimonsVoss transponders and/or MIFARE® SmartCards/SmartTags; inside is permanently engaged ready for use. | SHA*...C**2G2*** SHA*...D**2G2*** |
| Digital SmartHandle 3062 – Hybrid – Conventional Fastening with MO and G2 Functions for Euro Profile Electronic door handle for conventional mounting with screws, with handle lock designed for Euro Profile; outer side can only be operated with SimonsVoss transponders and/or MIFARE® SmartCards/SmartTags; inside is permanently engaged ready for use. | SHC*...E-L**2G2*** |
| Digital SmartHandle 3062 – Hybrid – Conventional Fastening with MO and G2 Functions for Swiss Round Electronic door handle for conventional mounting with screws, with handle lock designed for Swiss Round; outer side can only be operated with SimonsVoss transponders and/or MIFARE® SmartCards/SmartTags; inside is permanently engaged ready for use. | SHD*...E-L**2G2*** |

* Identifiers for profile:
 A = Euro Profile/Swiss Round/British Oval
 C = Euro Profile with mechanical override
 D = Swiss Round with mechanical override

** Identifiers for fastening system/backplate width:
 A = snap-in, narrow
 B = snap-in, wide
 C = conventional fastening, narrow
 D = conventional fastening, wide
 E-L = versions for mechanical override

*** Identifiers for reader technology/option:
 2 = hybrid
 G2 = with G2 functions

DIGITAL
SMART HANDLE 3062 –
HYBRID

OPTIONS

| Description | Order code |
|--|------------|
| PROFILE | |
| Euro Profile / Swiss Round / British Oval* | A |
| Euro Profile with mechanical override (MO) | C |
| Swiss Round with mechanical override (MO) | D |
| DOOR THICKNESS | |
| 39 – 60 mm | S |
| 59 – 80 mm | M |
| 79 – 100 mm | L |
| SPINDLE | |
| 7 mm | 07 |
| 8 mm | 08 |
| 8 mm (fire retardant doors) | F8 |
| 9 mm (fire retardant doors) | 09 |
| 10 mm (with adapter sleeve) | 10 |
| FASTENING SYSTEM/PLATE WIDTH | |
| Snap-in plate (41 mm) | A |
| Snap-in plate (53 mm) | B |
| Conventional fastening, narrow (41 mm) | C |
| Conventional fastening, wide (53 mm) | D |
| MO cut-out inside and outside, narrow (41 mm) | E |
| MO inside and outside cut-out, wide (53 mm) | F |
| MO inside blank, cut-out outside, narrow (41 mm) | G |
| MO inside blank, cut-out outside, wide (53 mm) | H |
| MO inside cut-out, outside blank, narrow (41 mm) | I |
| MO inside cut-out, outside blank, wide (53 mm) | J |
| MO inside and outside blank, narrow (41 mm) | K |
| MO inside and outside blank, wide (53 mm) | L |

*Adapter sleeve required (see Accessories)

DIGITAL
SMART HANDLE 3062 –
HYBRID

| Description | Order code |
|---|------------|
| CENTRES DISTANCE | |
| Conventional fastening | 00 |
| 70 mm (for snap-in only) | 70 |
| 72 mm (for Snap-in and Mechanical Override only) | 72 |
| 74 mm (for Swiss Round – Snap-in and Mechanical Override only) | 74 |
| 75 mm (for Snap-in and Mechanical Override only) | 75 |
| 78 mm (for Snap-in and Mechanical Override only) | 78 |
| 85 mm (for Snap-in and Mechanical Override only) | 85 |
| 88 mm (for Snap-in and Mechanical Override only) | 88 |
| 92 mm (for Snap-in and Mechanical Override only) | 92 |
| 94 mm (for Swiss Round – Snap-in and Mechanical Override only) | 94 |
| VERSION | |
| Engaged (for SmartHandle without electronics only) | 0 |
| Engages for use on one side (for all SmartHandles with electronics) | 1 |
| HANDLE VERSION, OUTSIDE | |
| L-shaped R (rounded) | A |
| L-shaped G (mitred) | B |
| U-shaped R (rounded) | C |
| U-shaped G (mitred) | D |
| U-shaped R (rounded), offset | E |
| U-shaped G (mitred), offset | F |
| HANDLE VERSION, INSIDE | |
| L-shaped R (rounded) | A |
| L-shaped G (mitred) | B |
| U-shaped R (rounded) | C |
| U-shaped G (mitred) | D |
| U-shaped R (rounded), offset | E |
| U-shaped G (mitred), offset | F |

DIGITAL
SMART HANDLE 3062 –
HYBRID

| Description | Order code |
|--|---------------|
| SURFACE | |
| Stainless steel, brushed | 1 |
| Brass version | 3 |
| READER TECHNOLOGY | |
| Hybrid | 2 |
| OPTIONS | |
| With G2 functions | G2 |
| Version with access control, time zone control and logging | ZK |
| Weatherproof version | WP |
| ADAPTER | |
| Adapter for a handle lock designed to hold a British Oval profile | SH.BO.ADAPT |
| SPINDLE | |
| Sleeve from 8 mm to 8.5 mm (10 units) | SH.HUELSE.8.5 |
| Sleeve from 7 mm to 8 mm (10 units) | SH.HUELSE.7.8 |
| DIRECT NETWORKING | |
| 'Network Inside' version with integrated LockNode | WNM.LN.I.SH |
| DIRECT NETWORKING FOR DIGITAL SMART HANDLE | |
| You can find our order placement guide SmartHandle in the retailer section on our website www.simons-voss.com . | |

DIGITAL SMART HANDLE 3062 – SCANDINAVIAN OVAL HYBRID

G2



BASIC VERSIONS.

| Description | Order code |
|--|-----------------|
| DIGITAL SMART HANDLE 3062 – SCANDINAVIAN OVAL – HYBRID | |
| Digital SmartHandle 3062 – Scandinavian Oval – Hybrid with G2 Functions Electronic door handle for mounting on doors, with handle lock designed for Scandinavian Oval; outer side can only be operated with SimonsVoss transponders and/or MIFARE® SmartCards/SmartTags; inside is permanently engaged ready for use. | SHB*2G2** |
| Digital SmartHandle 3062 – Scandinavian Oval – Hybrid with MO and G2 Functions Electronic door handle for mounting on doors, additional options for installing a mechanical cylinder as a secondary lock, with handle lock designed for Scandinavian Oval; outer side can only be operated with SimonsVoss transponders and/or MIFARE® SmartCards/SmartTags; inside is permanently engaged ready for use. | SHE*2G2** |

OPTIONS.

| Description | Order code |
|---|------------|
| PROFILE | |
| Scandinavian Oval | B |
| Scandinavian Oval with Mechanical Override (MO) | E |
| DOOR THICKNESS | |
| 33 – 54 mm | S |
| 53 – 74 mm | M |
| 73 – 94 mm | L |
| SPINDLE | |
| 7 mm | 07 |
| 8 mm | 08 |
| 8 mm (fire retardant doors) | F8 |
| 9 mm (fire retardant doors) | 09 |
| 10 mm (with adapter sleeve) | 10 |

* Identifiers for profile:

B = Scandinavian Oval

E = Scandinavian Oval with Mechanical Override

*** Identifier for reader technology/option:

2 = hybrid

G2 = with G2 functions

DIGITAL
SMART HANDLE 3062 –
SCANDINAVIAN OVAL –
HYBRID

| Description | Order code |
|--|------------|
| FASTENING SYSTEM/PLATE WIDTH | |
| Conventional fastening, narrow (41 mm) | C |
| Conventional fastening, wide (53 mm) | D |
| MO cut-out inside and outside, narrow (41 mm) | E |
| MO inside and outside cut-out, wide (53 mm) | F |
| MO inside blank, cut-out outside, narrow (41 mm) | G |
| MO inside blank, cut-out outside, wide (53 mm) | H |
| MO inside cut-out, outside blank, narrow (41 mm) | I |
| MO inside cut-out, outside blank, wide (53 mm) | J |
| MO inside and outside blank, narrow (41 mm) | K |
| MO inside and outside blank, wide (53 mm) | L |
| CENTRES DISTANCE | |
| Adapter fastening | 00 |
| 96 mm (not for Mechanical Override) | 96 |
| 105 mm (for Mechanical Override only) | 05 |
| VERSION | |
| Engages for use on one side | 1 |
| HANDLE VERSION, OUTSIDE | |
| L-shaped R (rounded) | A |
| L-shaped G (mitred) | B |
| U-shaped R (rounded) | C |
| U-shaped G (mitred) | D |
| U-shaped R (rounded), offset | E |
| U-shaped G (mitred), offset | F |

DIGITAL
SMART HANDLE 3062 –
SCANDINAVIAN OVAL –
HYBRID

| Description | Order code |
|---|-------------|
| HANDLE VERSION, INSIDE | |
| L-shaped R (rounded) | A |
| L-shaped G (mitred) | B |
| U-shaped R (rounded) | C |
| U-shaped G (mitred) | D |
| U-shaped R (rounded), offset | E |
| U-shaped G (mitred), offset | F |
| SURFACE | |
| Stainless steel, brushed | 1 |
| Brass version | 3 |
| READER TECHNOLOGY | |
| Hybrid | 2 |
| OPTIONS | |
| With G2 functions | G2 |
| Version with access control, time zone control and logging | ZK |
| Weatherproof version | WP |
| 'Network Inside' version with integrated LockNode | WNM.LN.I.SH |
| DIRECT NETWORKING FOR DIGITAL SMART HANDLE | |
| You can find our order placement guide SmartHandle in the retailer section on our website at www.simons-voss.com . | |

PASSIVE SMART CARD TECHNOLOGY

DIGITAL SMART RELAYS 2

3063



Simons Voss

DIGITAL SMART RELAY 2 3063

G2

Digital Smart Relay 2 3063 has been developed for system environments which use smart cards. It supports MIFARE® Classic, MIFARE Plus® and MIFARE® DESFire® reader systems. Smart Relay 2 is an electronic switch which can be activated with a SimonsVoss ID medium (transponder or smart card), thus fulfilling the function of an access control reader or a key switch. In System 3060, it opens electrically operated doors, gates and barriers, and switches lighting, heating and machines on and off.

It transmits data from ID media to third-party systems, such as time-and-attendance systems, cashless vending systems or facility management systems.

- ⚡ Instantly wireless network-ready
- ⚡ Release also possible using an external signal (SREL2.ZK.MH.G2.W)

CUSTOMER BENEFIT

- ⚡ Intelligent additional component for locking devices
- ⚡ Optional solution with integrated and external card readers for MIFARE® cards (Classic, DESFire®, Plus)
- ⚡ Connection to third-party systems, e.g. barriers, gates, machines, time-and-attendance systems and access control readers
- ⚡ It can be used as a gateway in a virtual network

SYSTEM SPECIFICATIONS AND INTERDEPENDENCIES WITH OTHER PRODUCTS

LSM

- ⚡ LSM 3.1 SP1 and higher

Network

- ⚡ Virtual network and online
- ⚡ You need to order the ZK version to use it as a gateway in a virtual network

Miscellaneous

- ⚡ Must be integrated into a G2 or mixed locking system.

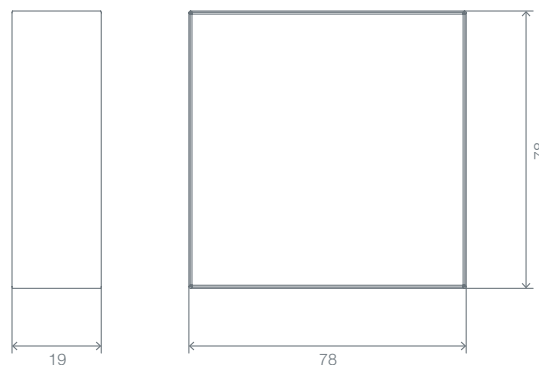

Measurements indicated in mm

TECHNICAL SPECIFICATIONS

- ⚡ Housing made of white plastic (polyamide 6.6)
Dimensions: 78 x 78 x 19 mm (H x W x D)
Semi-transparent base plate
- ⚡ Protection rating: IP 20
IP54 as WP variant
IP65 with additional seal for the cable inlet
- ⚡ Humidity: < 95 % without condensation
- ⚡ Vibrations: 15 G for 11 ms,
6 shocks as per IEC 68-2-27
Not approved for use when subject to permanent vibrations
- ⚡ Circuit board dimensions: 50 x 50 x 14 mm (H x W x D)
- ⚡ Power supply voltage: 9–24 V DC
- ⚡ Power limitation: Mains adapter must be limited to 15 V A
- ⚡ Standby current: < 100 mA
- ⚡ Max. current: < 300 mA
- ⚡ Pulse duration can be programmed between 1 and 25.5 sec.

DIGITAL
SMART RELAY 2
3063

TECHNICAL SPECIFICATIONS FOR OUTPUT RELAY

- ⚡ Type: NO contact
Normally open contact, reversible
- ⚡ Continuous current: max. 1.0 A
- ⚡ Switch-on current: max. 2.0 A
- ⚡ Switching voltage: max. 24 V
- ⚡ Switching power: 10⁶ activations at 30 V A
- ⚡ Multi-function connections F1, F2, F3: max. 24 V DC,
max. 50 mA
- ⚡ Loggable access events: 3,600 access events
200 access events as gateway
- ⚡ Time zone groups: 100+1
- ⚡ Number of transponders that can be managed per locking
cylinder: up to 64,000
- ⚡ Networking capability: network-ready with integrated Lock Node
(WNM.LN.I.SREL2.G2) or via external Lock Node with added
door monitoring function
- ⚡ Other: Can be used as gateway, freely configurable

PRODUCT VERSIONS

Digital Smart Relay 2 3063

for active transponders and also designed for use with passive smart cards.

Basic version in white housing, relay contact as NO contact (reversible to break contact); can only be operated with direct current (9 to 24 V DC); can be directly networked with integrated Lock Node (must be ordered separately), with connection available for an external antenna (SREL.AV). With access control, time zone management and events logging. With serial port and the option of triggering the SREL2 by means of an external circuit (isolated NO contact). Can be used as gateway in a virtual network (active transponder). Designed to also house an internal MIFARE® card reader and able to connect one or two additional external MIFARE card readers. Can be used as gateway in a virtual network (passive smart cards).

SREL2.ZK.MH.G2.W

Smart card reader, internal

For inserting into the Smart Relay 2 relay circuit board for smart cards (SREL2.ZK.MH.G2.W), operated with MIFARE® Classic, MIFARE Plus® or MIFARE® DESFire® smart cards

SC.M.I.G2

Smart card reader, external

For installation in a non-secured area; connection to Smart Relay 2 for smart cards via cable (not included in supply package; recommended cable type: Cat5); Smart Relay 2 operated with MIFARE® Classic, MIFARE Plus® or MIFARE® DESFire® smart cards

SC.M.E.G2.W

Weatherproof version for external smart card readers, including connection cable (about 1 m long), IP54

.WP

'Network Inside' version with integrated Lock Node

WNM.LN.I

PASSIVE SMART CARD TECHNOLOGY
OTHER PRODUCTS



DIGITAL PADLOCKS

G2



TECHNICAL SPECIFICATIONS

- ⌘ Dimensions: (W x H x D) with cylinder thumb-turn
60 x 72.5 x 25 mm
- ⌘ Shackle diameter: 11 mm
- ⌘ Versions: Padlock 2 (PL2): non-self-locking
Padlock 3 (PL3): self-locking
- ⌘ Inside height of shackle: PL2: 35 mm; PL3 (self-locking) 50 mm
- ⌘ Protection rating: IP66
- ⌘ Battery type: 2x CR2450, 3 V, Lithium.
- ⌘ Battery life:
Up to 65,000 operations or 6 years on standby
- ⌘ Temperature range:
Operational: -25°C to +55°C
In storage (temporary): -45°C to +70°C
In storage (long-term): 0°C to +30°C
- ⌘ Up to 3,000 access events can be stored
- ⌘ Time zone groups: 5+1 (G1), 100+1 (G2)
- ⌘ Up to 64,000 smart cards can be managed per padlock
(depending on the configuration / template)
- ⌘ Up to 64,000 locking devices can be managed per smart card
(depending on the configuration / template)
- ⌘ Network-ready with integrated Lock Node
- ⌘ Freely configurable

PRODUCT VERSIONS

| | |
|--|-----------------|
| SimonsVoss Padlock MIFARE® | PL2.MP.WP.G2 |
| SimonsVoss Padlock MIFARE® ZK | PL2.MP.ZK.WP.G2 |
| SimonsVoss Self-Locking Padlock MIFARE® | PL3.MP.WP.G2 |
| SimonsVoss Self-Locking Padlock MIFARE® ZK | PL3.MP.ZK.WP.G2 |
| 'Network Inside' version with integrated Lock Node | WNM.LN.I |

MULTI-NETWORKING





MODE OF OPERATION WAVE NET RADIO NETWORK

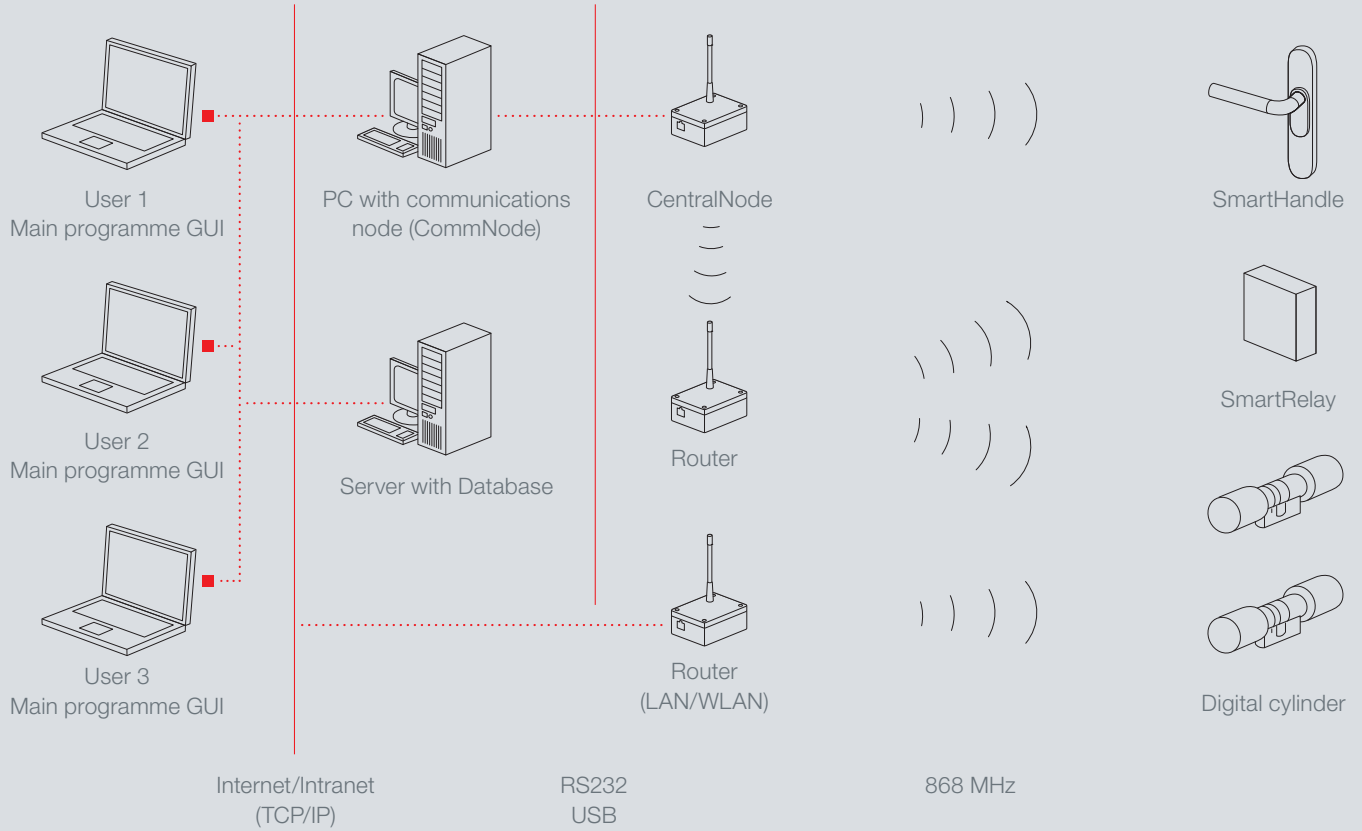

WAVE NET RADIO NETWORK 3065

G1

G2

Radio network for connecting digital locking cylinders, Smart Handles and Smart Relays to a central computer. Data is transmitted via the 868 MHz frequency band. Other transfer media are also available. These are: USB or RS232 for connecting to a central PC, RS485 for cable-based backbones, LAN and WLAN for integration into existing building networks.

The different transfer media can be interlinked with one another in virtually any way using corresponding router nodes.

COMPONENT ASSEMBLIES

- ⚡ Locking system software:
The lock system is controlled and managed from a central PC using Locking System Management (LSM) software.
- ⚡ WaveNet Central Node:
Forms the central node in a WaveNet network. It is connected to the central PC via a RS232 or USB port. LAN or WLAN routers (TCP/IP) may also be connected at any point in the building network as an alternative to the central node. They then form the central node of a local WaveNet sub-network.
- ⚡ WaveNet Routing Node:
Routing nodes interlink the different network segments with one another in a WaveNet network. Different transmitting media can thus be interconnected with one another (example: A WNM.RN.CR router connects a cable segment [C] with a radio segment [R]).
- ⚡ WaveNet Repeater Node:
A repeater node regenerates and amplifies signals along very long cable segments (> 900m).
- ⚡ WaveNet Lock Node:
This device is fitted next to locking cylinders, Smart Handles or Smart Relays which are to be networked. It communicates with the locking components via the time-tested B-field interface and with the nearest routing node via the 868 MHz radio interface (alternatively via an RS485 cable port). The Lock Node provides additional I/Os to monitor door contacts and actuate external systems.

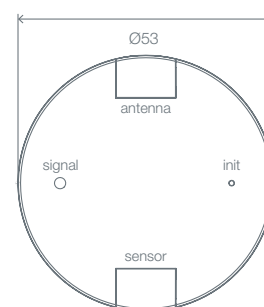

Measurements indicated in mm

TECHNICAL SPECIFICATIONS FOR WAVE NET LOCK NODE

- ⚡ Housing made from light grey ABS plastic
- ⚡ Dimensions: 37 x 53 mm (H x Ø)
- ⚡ Power supply: 2 batteries (type: 2/3 AA), lithium, 3.6 V
- ⚡ Transmission power: approx. 1.8 mW at approx. 2.5 dBm
- ⚡ Frequency: 868.xx – 870.xx MHz
- ⚡ Inputs: 3 x isolated
- ⚡ Output: open drain; max. switching voltage: 25 V DC; max. starting current: 2 A; continuous current: 650 mA; internal resistance (AN): 0.5 Ohm
- ⚡ Battery life: up to six years

TECHNICAL SPECIFICATIONS FOR WAVE NET ROUTER

- ⚡ Housing made from light grey plastic (polycarbonate)
- ⚡ Housing dimensions for central node and routing node: 40 x 100 x 65 mm, with antenna 130 x 100 x 65 mm (W x H x D)
- ⚡ Power supply central node and routing nodes: 9 V ... 12 V DC
- ⚡ Output: max. 3 V A
- ⚡ Radio module transmission power: max. 8 dBm (6.3 mW) in the antenna
- ⚡ Radio module frequency: 868.xx – 870.xx MHz
- ⚡ All routers include connecting terminals for an external plug-in power supply and an external transmission and receiver antenna
- ⚡ Power supply:
From a regulated plug-in power supply WNM.POWER.SUPPLY.PPP, WNM.RN.WR / WNM.RN.ER: 9 V...48 V DC, WNM.RN.CR: 9 V...12 V DC, WNM.RN.CR also via PoE (Power over Ethernet)

WAVE NET RADIO NETWORK 3065

WaveNet Routing Node as converter from
WLAN to 868 MHz frequency



PRODUCT VERSIONS

WAVE NET RADIO NETWORK 3065 – HARDWARE AUTO-CONFIGURATION

All hardware products with item numbers starting with 'WNM' are designed for auto-configuration. The WaveNet Manager (software tool) allows you to automatically address all WNM components by radio or by cable. WaveNet Manager can be downloaded for free at www.simons-voss.com.

| | |
|--|---------------|
| WaveNet Central Node for auto-configuration with RS232/RS485 port to connect to a PC/server | WNM.CN.SC |
| WaveNet Central Node for auto-configuration with RS232/868 MHz radio interface to connect to a PC/server | WNM.CN.SR |
| WaveNet Central Node for auto-configuration with USB/RS485 port to connect to a PC/server, in anthracite-coloured housing | WNM.CN.UC |
| WaveNet Central Node for auto-configuration with USB/868 MHz radio interface to connect to a PC/server, in anthracite-coloured housing | WNM.CN.UR |
| WaveNet Repeater Node for auto-configuration with two RS485 ports for line extension in the backbone, including connecting terminals for external plug-in power supply | WNM.RP.CC |
| WaveNet Routing Node for auto-configuration with 868 MHz radio module, including connecting terminals for external plug-in power supply and an external transmission and receiver antenna | WNM.RN.R |
| WaveNet Routing Node for auto-configuration with two RS485 ports for segment extension | WNM.RN.CC |
| WaveNet Routing Node for auto-configuration to convert from RS485 port to 868 MHz frequency, to use the routing node as a backbone, including connecting terminals for external plug-in power supply and an external transmission and receiver antenna | WNM.RN.CR |
| WaveNet Routing Node for auto-configuration to convert from 868 MHz frequency to RS485 port, to use the routing node as a backbone, including connecting terminals for external plug-in power supply and an external transmission and receiver antenna | WNM.RN.RC |
| WaveNet LockNode for auto-configuration without I/O function (battery operated) | WNM.LN.R.O./O |
| WaveNet LockNode for auto-configuration with 868 MHz radio interface, featuring three inputs and one output (battery-operated) | WNM.LN.R |
| WaveNet LockNode for auto-configuration with RS485 port, featuring three inputs and one output | WNM.LN.C |
| WaveNet Routing Node for auto-configuration as converter from Ethernet to 868 MHz frequency; includes connecting terminals for an external plug-in power supply and an external transmission and receiver antenna; Power over Ethernet capable (PoE 802.3af) | WNM.RN.ER |
| WaveNet Routing Node for auto-configuration as converter from Ethernet to the RS485 port; includes connecting terminals for an external plug-in power supply; Power over Ethernet-capable (PoE 802.3af) | WNM.RN.EC |
| WaveNet Routing Node for auto-configuration as converter from WLAN to 868 MHz frequency; includes connecting terminals for an external plug-in power supply | WNM.RN.WR |
| WaveNet Routing Node for auto-configuration as converter from WLAN to the RS485 port; includes connecting terminals for an external plug-in power supply | WNM.RN.WC |

WAVE NET ROUTER – PROTECTIVE FUNCTION

G1

G2

The latest router generation from SimonsVoss offers unique protective functions for door monitoring, such as 'Lock doors in gunman incidents', 'Release doors in the event of fire' or automatic signals in the case of breakdowns and emergency situations.

Determining overall situations and always making the right decisions is a task which presents an enormous challenge for building systems. The new generation of SimonsVoss routers can be ordered with a protective function as standard which offers the following characteristics:

- ⌘ Blocking of doors in the event of a gunman attack alarm
- ⌘ Blocking of individual doors with special gunman attack transponders or cards
- ⌘ Release of doors in the event of a fire alarm
- ⌘ Release of doors in the event of a distress call (nursing staff emergency call, panic situation)
- ⌘ Switching of powered systems such as lighting and heating
- ⌘ Transmission of signals in the event of breakdown or faults in the building, such as excessively high temperatures, water getting inside the building, incorrect fill levels in tanks. Can feature simultaneous releasing/opening of doors
- ⌘ Operates even if communication networks are already down
- ⌘ A router with a protective function can manage up to 250 doors
- ⌘ The locking device must feature access control functions if output signals are to be used



SYSTEM SPECIFICATIONS AND INTERDEPENDENCIES WITH OTHER PRODUCTS

- ⌘ WaveNet Manager 2.3
(free download online from SimonsVoss website)
- ⌘ WNM components (LN, central/ routing node, etc.)
- ⌘ G1 and/or G2 locking devices (no distinction)
- ⌘ LSM 3.1 SP2 and higher (if there is network connection to application software)

TECHNICAL SPECIFICATIONS

- ⌘ Housing: light grey plastic (polycarbonate)
- ⌘ Dimensions housing for central/routing nodes:
100 x 65 x 40 mm or 100 x 65 x 130 mm (with antenna)
- ⌘ Power supply for central/routing nodes:
9V ... 12V DC regulated plug-in power supply
WNM.RN.ER, WNM.RN.EC also Power over Ethernet (PoE) IEEE 802.3af
- ⌘ Output (for all central/routing nodes): max. 3 V A
- ⌘ Radio module transmission power:
max. 8 dBm (6.3mW) in the antenna
- ⌘ Transmission frequency: 868.xx–870 MHz

WAVE NET ROUTER – PROTECTIVE FUNCTION

PRODUCT VERSIONS

All central nodes and routing nodes with protective function:
gunman attack, block lock, emergency release, remote opening

WaveNet Central Node with protective function for auto-configuration
with RS232/RS485 port to connect to a PC/server

WNM.CN.SC.IO

WaveNet Central Node with protective function for auto-configuration
with RS232/868 MHz radio interface to connect to a PC/server

WNM.CN.SR.IO

WaveNet Central Node with protective function for auto-configuration
with USB/RS485 port to connect to a PC/server, in anthracite-coloured housing

WNM.CN.UC.IO

WaveNet Central Node with protective function for auto-configuration
with USB/868 MHz radio interface to connect to a PC/server, in anthracite-coloured housing

WNM.CN.UR.IO

WaveNet Routing Node with protective function for auto-configuration
with 868 MHz radio module, including connecting terminals for external plug-in power supply and an
external transmission and receiver antenna.

WNM.RN.R.IO

WaveNet Routing Node with protective function for auto-configuration
with two RS485 ports for segment extension

WNM.RN.CC.IO

WaveNet Routing Node with protective function for auto-configuration
used to convert from the RS485 port to 868 MHz frequency, to allow the routing node to be used as a
backbone; includes connecting terminals for external plug-in power supply and an external transmission
and receiver antenna

WNM.RN.CR.IO

WaveNet Routing Node with protective function for auto-configuration
used to convert from 868 MHz frequency to the RS485 port, to allow the routing node to be used as a
backbone; includes connecting terminals for external plug-in power supply and an external transmission
and receiver antenna

WNM.RN.RC.IO

WaveNet Routing Node with protective function for auto-configuration
used to convert from Ethernet to 868 MHz frequency; includes connecting terminals for external plug-in
power supply and an external transmission and receiver antenna; Power over Ethernet-capable (PoE
802.3af)

WNM.RN.ER.IO

WaveNet Routing Node with protective function for auto-configuration
used to convert from Ethernet to the RS485 port; includes connecting terminals for external plug-in
power supply; Power over Ethernet-capable (PoE 802.3af)

WNM.RN.EC.IO

WaveNet Routing Node with protective function for auto-configuration
used to convert from WLAN to 868 MHz frequency, including connecting terminals for external plug-in
power supply
(8-week delivery period upon request)

WNM.RN.WR.IO

WaveNet Routing Node with protective function for auto-configuration
used to convert from WLAN to RS485 port, including connecting terminals for external plug-in power
supply (8-week delivery period upon request)

WNM.RN.WC.IO

WAVE NET RADIO NETWORK 3065 DIRECT NETWORKING

G1

G2

The WaveNet Network Thumb-turn Cover incorporates the Lock Node into the metal cover on the electronics side of a locking cylinder. It thus enables direct networking without the need to fit additional Lock Nodes next to the door and you can also dispense with I/Os. The network thumb-turn cover can be retrofitted very easily by replacing the cover on the electronics side of a locking cylinder. New cylinders for direct networking can be ordered as the Network Inside version .WNM.



TECHNICAL SPECIFICATIONS

- ⚡ Retrofit network thumb-turn cover for networking TN4 locking cylinders The network thumb-turn cover can be used with all versions of Digital Locking Cylinder 3061 as from Q2/2008
- ⚡ Standard stainless steel version
- ⚡ Brass version (.MS)
- ⚡ Dimensions: approx. 25 x 30 mm (Lx Ø)
- ⚡ Power supply: from TN4 locking cylinder
- ⚡ Battery life: up to 150,000 locking operations or up to five years on stand-by
- ⚡ Power consumption: without data traffic approx. 6 µA; with data traffic approx. 30 mA
- ⚡ Max. transmission power: approx. 1.8 mW at approx. 2.5 dBm
- ⚡ Receiver sensitivity: -90 dBm
- ⚡ Range to central/routing node: up to 30 m depending on the building structure
- ⚡ Temperature range: Operational: -15 °C to +50 °C
In storage: -35 °C to +50 °C

WAVE NET RADIO NETWORK
3065
DIRECT NETWORKING

PRODUCT VERSIONS

FOR DIGITAL LOCKING CYLINDER 3061 – ACTIVE AND HYBRID

| | |
|--|----------|
| Network thumb-turn cover for auto-configuration as retrofit thumb-turn cover, for direct networking, stainless steel | WNM.LN.I |
| Brass design | .MS |

FOR DIGITAL LOCKING CYLINDER 3061 – PASSIVE (.MP) (G2 ONLY)

| | |
|---|-------------|
| Retrofit thumb-turn cover for auto-configuration with integrated antenna and separate network circuit board for direct networking, stainless steel design | WNM.LN.I.MP |
|---|-------------|

FOR SMART HANDLES 3062

| | |
|--|-------------|
| Lock Node for integration into digital door fittings, to directly network Smart Handle 3062 (can be retrofitted) | WNM.LN.I.SH |
|--|-------------|

FOR SMART RELAY 3063

| | |
|--|------------------|
| Lock Node to be integrated into the Smart Relay housing for direct networking of Smart Relay 3063 with auto-configuration (can be retrofitted) | WNM.LN.I.SREL.G2 |
|--|------------------|

FOR SMART RELAY 2 3063

| | |
|--|-------------------|
| Lock Node to be integrated into the Smart Relay 2 housing for direct networking of Smart Relay 2 with auto-configuration | WNM.LN.I.SREL2.G2 |
|--|-------------------|

FOR PADLOCKS – ACTIVE

| | |
|--|-----------------|
| Network thumb-turn cover for auto-configuration as retrofit thumb-turn cover, for direct networking, stainless steel | WNM.LN.I |
| Network thumb-turn cover for auto-configuration as retrofit thumb-turn cover, for direct networking, stainless steel | WNM.LN.I.KNAUF7 |

FOR PADLOCKS – PASSIVE

| | |
|---|-------------|
| Retrofit thumb-turn cover for auto-configuration with integrated antenna and separate network circuit board for direct networking, stainless steel design | WNM.LN.I.MP |
|---|-------------|

WAVE NET RADIO NETWORK 3065 – ACCESSORIES AND LOCK NODE LICENCES

PRODUCT VERSIONS

WAVE NET ACCESSORIES

| | |
|--|---------------------|
| External power supply for WaveNet Central Nodes, Routing Nodes and Repeater Nodes | WN.POWER.SUPPLY.PPP |
| External plug-in power supply for WaveNet Lock Node with RS485 port (WNM.LN.C) | WN.POWER.SUPPLY.LNC |
| External antenna for WaveNet Lock Nodes | WN.LN.ANTV |
| Battery set for WaveNet Lock Node, 10 units | WN.BAT.SET |
| Sensor cable for connection to WaveNet Lock Nodes (WNM.LN.R/WNM.LN.C) for monitoring doors | WN.LN.SENSOR.CABLE |
| Connection cable to connect Smart Relay G1/G2 to a WaveNet Lock Node | WN.WIRED.BF.G2 |
| Connecting cable to use the I/O function to wire different input/output connections Cable 5 m long | WNM.CABLE.IO |
| Lock Node tester for analysing a SimonsVoss WaveNet Radio Network 3065 at 868 MHz/915 MHz (in the US); consists of one base and one mobile station; users are required to receive training before use; price includes 2 hours of training over the phone | WN.TESTER.BAMO.EU |
| Base station | WN.TESTER.BASIS.EU |
| Mobile station | WN.TESTER.MOBILE.EU |
| Training per hour | DIENST |

WAVE NET RADIO NETWORK 3065 – LOCK NODE LICENCES

| | |
|---|------------|
| For networks with max. 12 Lock Nodes | TP.SW.12 |
| For networks with max. 48 Lock Nodes | TP.SW.48 |
| For networks with max. 128 Lock Nodes | TP.SW.128 |
| For networks with max. 258 Lock Nodes | TP.SW.258 |
| For networks with max. 516 Lock Nodes | TP.SW.516 |
| For networks with max. 1,032 Lock Nodes | TP.SW.1032 |
| For networks with max. 2,064 Lock Nodes | TP.SW.2064 |
| For networks with > 2,064 Lock Nodes | on request |

LSM SOFTWARE





LSM SOFTWARE FOR EFFECTIVE USE OF INTELLIGENT SYSTEM COMPONENTS

OVERVIEW.

Intelligent components form the core of a digital locking and access control system. The software application is the unifying element which ensures all tasks are completed quickly and conveniently: issuing transponders to new members of staff, programming locking cylinders with current authorisations and viewing access events over the network.

The more complicated requirements are, the more comprehensive the software needs to be. Anyone who needs to perform standard tasks requires just one simple application. A large corporate group with offices all over the world needs a package that offers high performance.

System 3060 allows you to choose the right software from a range of different solutions. Individual versions are all compatible, ensuring future requirements will be met.

FOR SYSTEMS LARGE AND SMALL

Very small systems, particularly those used privately, can be configured quickly at a low cost without the need for a PC or special software by using Programming Transponder 3067.

The Locking System Management (LSM) software is used for all other systems. The software consists of editions and modules brought together to meet your needs and is able to grow to meet your changing requirements. LSM Starter is particularly suitable for systems with up to 20 doors and 100 users. LSM Basic Edition is sufficient to manage locking plans in small to medium-sized systems easily. You can upgrade from basic locking plan software to administration software with the LSM 'Business' and 'Professional' editions: database-based, multi-user- and multi-client-enabled solutions with an integrated reporting function. When it comes to access control systems with several locations, using a WaveNet Radio Network will simplify administrative work and provide a considerable cost benefit.

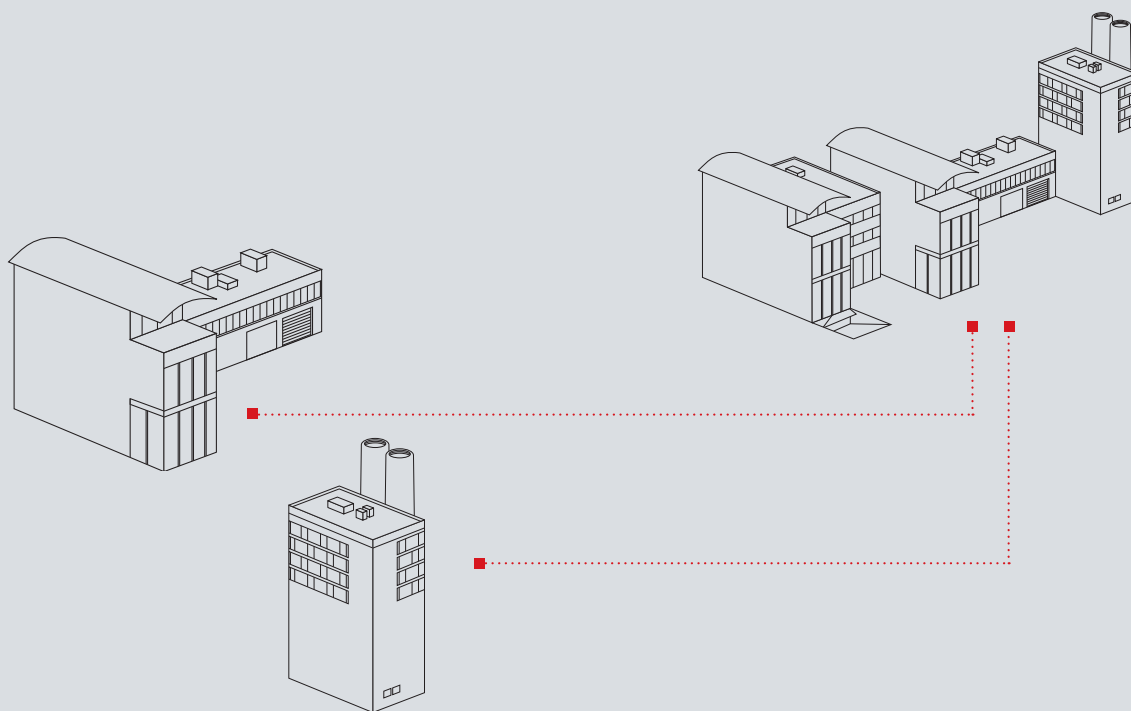

BASIC STRUCTURE

- ⚡ LSM provides a basic data structure which grows to match your system as it increases in size. There are different components and modules which can enhance and extend the existing installation by adding new functions and increasing performance.
- ⚡ The database engine: LSM Business Edition is based on a renowned database server, which is simple to install and creates no additional administrative work. It guarantees data security and program stability and performance.
- ⚡ Communication nodes establish connections to existing programming devices and networks. They process tasks and events.
- ⚡ The user program with a graphical user interface (GUI) is installed on all clients. The graphical user interface allows you to view and edit locking plan structures on different screens featuring a compressed or detailed format.

INTERFACES

- ⚡ Database for read access
- ⚡ Interfaces to the PDA database and to the Event Agent
- ⚡ Messaging interface for sending text messages and emails
- ⚡ ASCII interface
- ⚡ LDAP interface for import
- ⚡ Software Integration Kit (SIK) to exchange data with third-party systems (details on request)

LSM SOFTWARE EDITIONS AND MODULES OVERVIEW

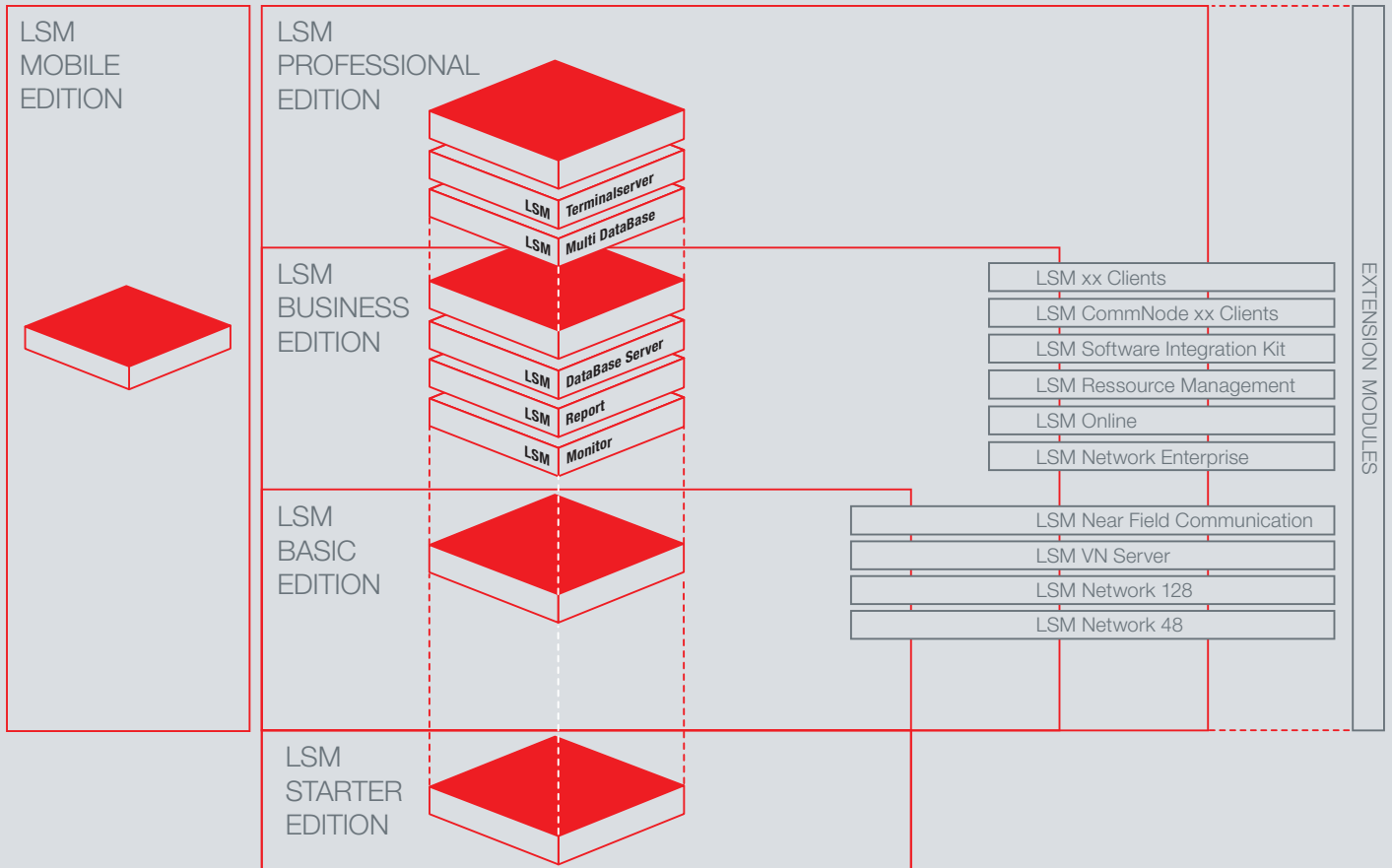

LSM SOFTWARE EDITIONS AND MODULES OVERVIEW

| LSM MODULE | LSM EDITIONS | | | | LSM DEMO VERSIONS | |
|-------------------------------|--------------|-------|----------|--------------|-------------------|----------|
| | Starter | Basic | Business | Professional | Basic | Business |
| LSM Basic Functions | • | • | • | • | • | • |
| LSM Monitor | X | ◦ | • | • | • | • |
| LSM Report | X | ◦ | • | • | • | • |
| LSM Database Server | X | ◦ | • | • | X | • |
| LSM Network 48 | X | ◦ | ◦ | ◦ | X | • |
| LSM Network 128 | X | ◦ | ◦ | ◦ | X | • |
| LSM Network Enterprise | X | X | ◦ | ◦ | X | • |
| LSM Near Field Communication | X | ◦ | • | • | • | • |
| LSM VN Server | X | ◦ | ◦ | ◦ | X | • |
| LSM Online | X | X | ◦ | ◦ | X | • |
| LSM Resource Management | X | X | ◦ | ◦ | X | • |
| LSM Comm Node 05 Clients | X | X | ◦ | ◦ | X | X |
| LSM Comm Node 10 Clients | X | X | ◦ | ◦ | X | X |
| LSM Comm Node Enterprise | X | X | ◦ | ◦ | X | X |
| LSM Software Integration Kit | X | X | ◦ | • | X | X |
| LSM Multi Database | X | X | ◦ | • | X | X |
| LSM Terminal Server | X | X | ◦ | • | X | X |
| LSM 03 Clients | X | X | ◦ | ◦ | X | X |
| LSM 05 Clients | X | X | ◦ | ◦ | X | X |
| LSM 10 Clients | X | X | ◦ | ◦ | X | X |
| LSM 25 Clients | X | X | ◦ | ◦ | X | X |
| LSM 50 Clients | X | X | ◦ | ◦ | X | X |
| Additional clients on request | | | | | | |
| LSM Mobile Edition | ◦ | ◦ | ◦ | ◦ | X | X |

• Included ◦ Available as option X Not available

LSM SOFTWARE CONCEPTS AND TOPOLOGIES

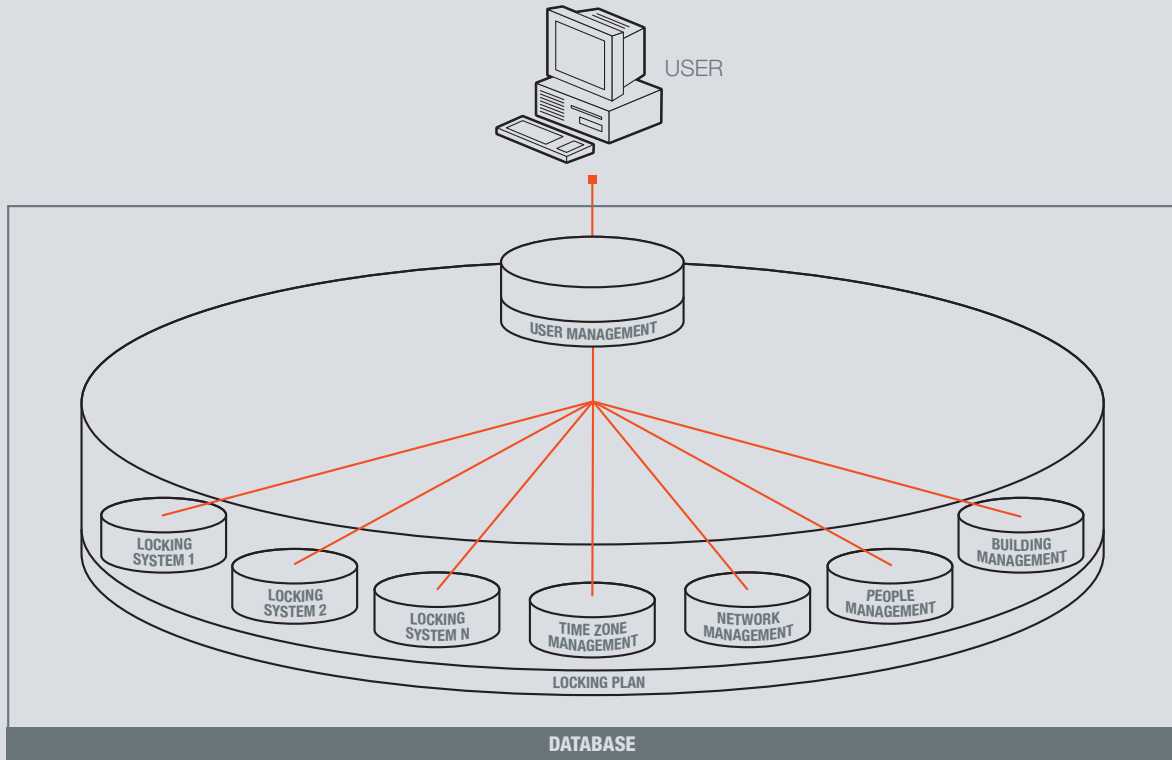

LSM BASIC EDITION

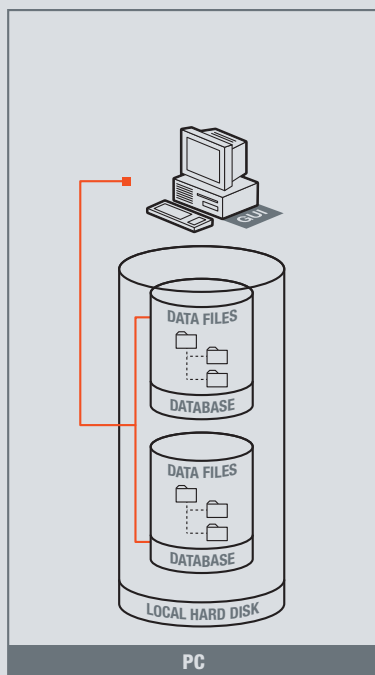

LSM BUSINESS EDITION

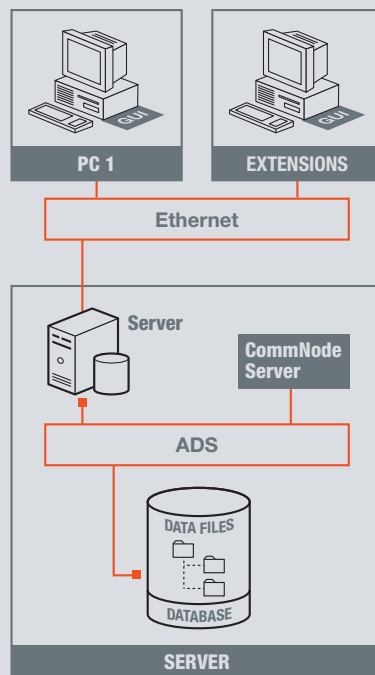

LSM PROFESSIONAL EDITION

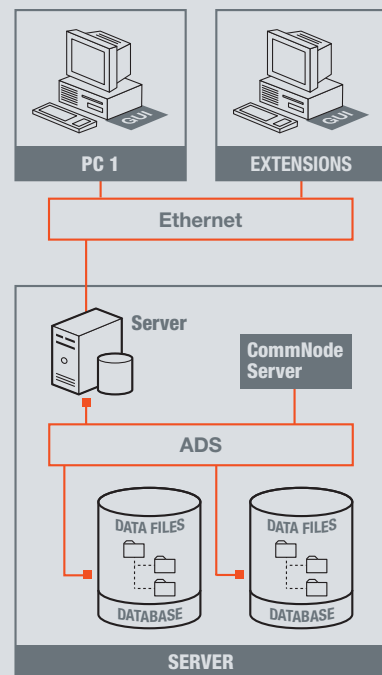

GUI: graphical User Interface
ADS: Advantage Database Server

LSM SOFTWARE EDITIONS

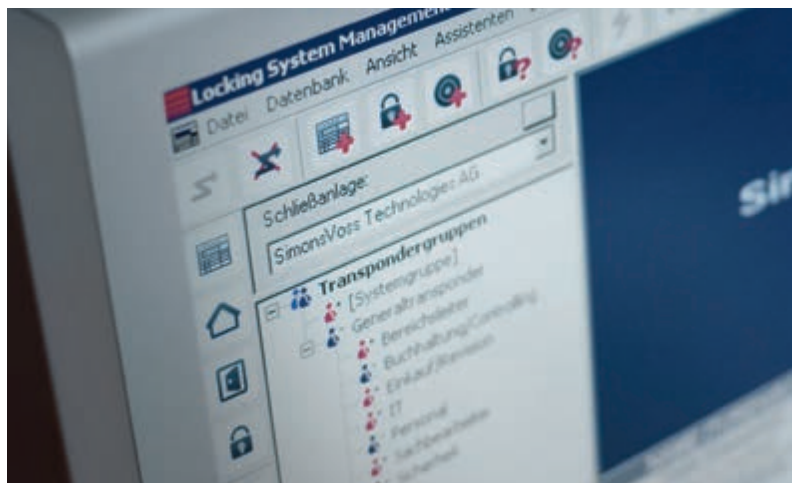

LSM STARTER EDITION

Single-user version, no network administration, local installation of software and data on one computer, no extension based on modules

- ⌘ G2 lock systems (100 transponders, 20locking devices, 100 time zones)
- ⌘ Active and passive systems (no mixed operation)
- ⌘ Functions:
 - individual authorisations for transponders or smart cards
 - Data exchange with portable terminal devices (PDA, netbook, tablet PC)
- ⌘ Upgrade to LSM Basic possible

LSM BASIC EDITION.

Single-user version, no network administration, local installation of software and data on one computer

- ⌘ G1 locksystems (8,000 transponders, 16,000 locks, 5+1 time zones)
- ⌘ G2 lock systems (64,000 transponders, 64,000 lock devices, 100 timezones)

Functions:

- ⌘ Transponder groups
- ⌘ Areas for mapping building and organisationalstructures (first level)
- ⌘ Use of multiple lock systems
- ⌘ Transfer of existing locking plans (import)
- ⌘ Data exchange with portable terminal devices (PDA, netbook, tablet PC)
- ⌘ Basis for further system expansion

LSM BUSINESS EDITION

Same functions as LSM Basic, includes Monitor (logging, audit-compliant), Report and Database modules

LSM PROFESSIONAL EDITION

Same functions as LSM Business, extended by adding option of using several databases on the server and operating in a terminal server environment

LSM MOBILE EDITION

For programming with a portable terminal device (PDA, netbook, tablet PC)

SERVICE LEVEL AGREEMENT STANDARD AND PREMIUM.

Modern software solutions offer a whole range of functions that make everyday life simpler. But even with intensive training and day-to-day experience of using the software, problems can still arise. You are guaranteed a quick solution with our various support levels (Service Level Agreement – SLA). With 'SLA Standard' you receive helpline user support for LSM. If you enter into an 'SLA Premium' agreement, you will receive additional online support and automatic LSM software updates. You must enter into one of these service level agreements for LSM.BUSINESS and LSM.PROFESSIONAL.

LSM STARTER EDITION

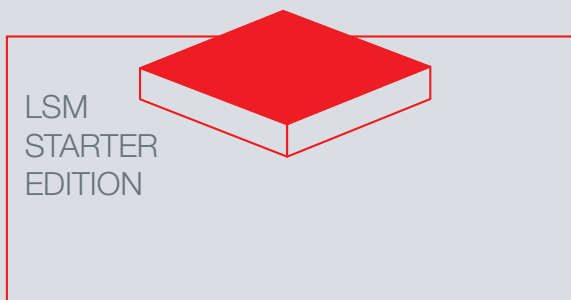

SHORT PRODUCT DESCRIPTION

Many software packages guide users through a large number of masks. LSM Starter Edition contains just the matrix screen, where you can access all other dialogues by clicking on the item. There are step-by-step wizards or a simple, one-click solution for standard tasks such as creating a new ID medium or configuring a new door.

SYSTEM SPECIFICATIONS AND INTERDEPENDENCIES WITH OTHER PRODUCTS

LSM Starter allows you to programme SimonsVoss components offline. It supports the current G2 protocol generation and can manage both projects with passive cards and active transponders.

TECHNICAL SPECIFICATIONS

- ⚡ Supported operating systems Windows XP, Vista, Windows 7 and Windows 8
- ⚡ Integrated database: ADS
- ⚡ Number of doors: max. 20
- ⚡ Number of media: max. 100
- ⚡ Active media: SimonsVoss G2 transponders
- ⚡ Passive media MIFARE® Classic and MIFARE® DESFire®
- ⚡ Upgrade to LSM Basic, LSM Business and LSM Professional Edition possible at any time

LSM BASIC EDITION MODULES

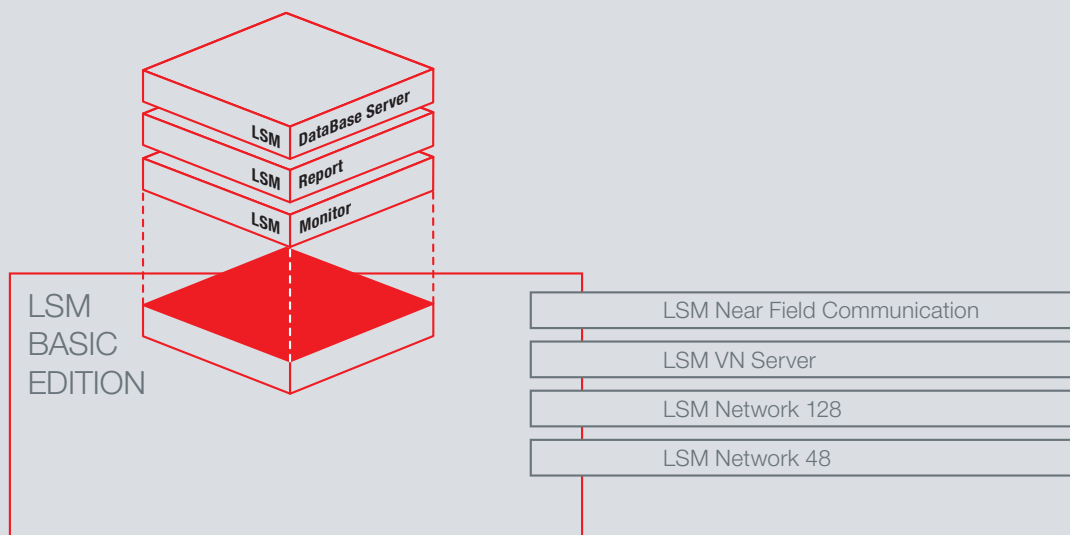

MODULES FOR LSM BASIC EDITION

The following extension modules can be ordered for LSM Basic Edition:

- ⚡ LSM NETWORK 48:
Network functionality for a maximum of 48 networked components
- ⚡ LSM NETWORK 128:
Network functionality for a maximum of 128 networked components
- ⚡ LSM VN SERVER:
Virtual network, automatic distribution of authorisation information in the G2 system via gateways and transponders to ensure easy SimonsVoss system administration SimonsVoss systems
- ⚡ LSM NEAR FIELD COMMUNICATION:
To upgrade to include NFC technology in conjunction with a smart phone

EXTENSION MODULES

- ⚡ LSM MONITOR:
Logging of system changes in the software (audit compliance)
- ⚡ LSM REPORT:
Comprehensive reporting system for displaying locking system information, such as the transponder issue log and the authorisation list per transponder or locking device
- ⚡ LSM DATABASE SERVER:
Database server, hierarchical view and inheritance of authorisations, user roles; network capability for a customer's LAN, client-server operation, multi-user capability (simultaneous access), communication nodes on other computers

LSM BUSINESS EDITION MODULES

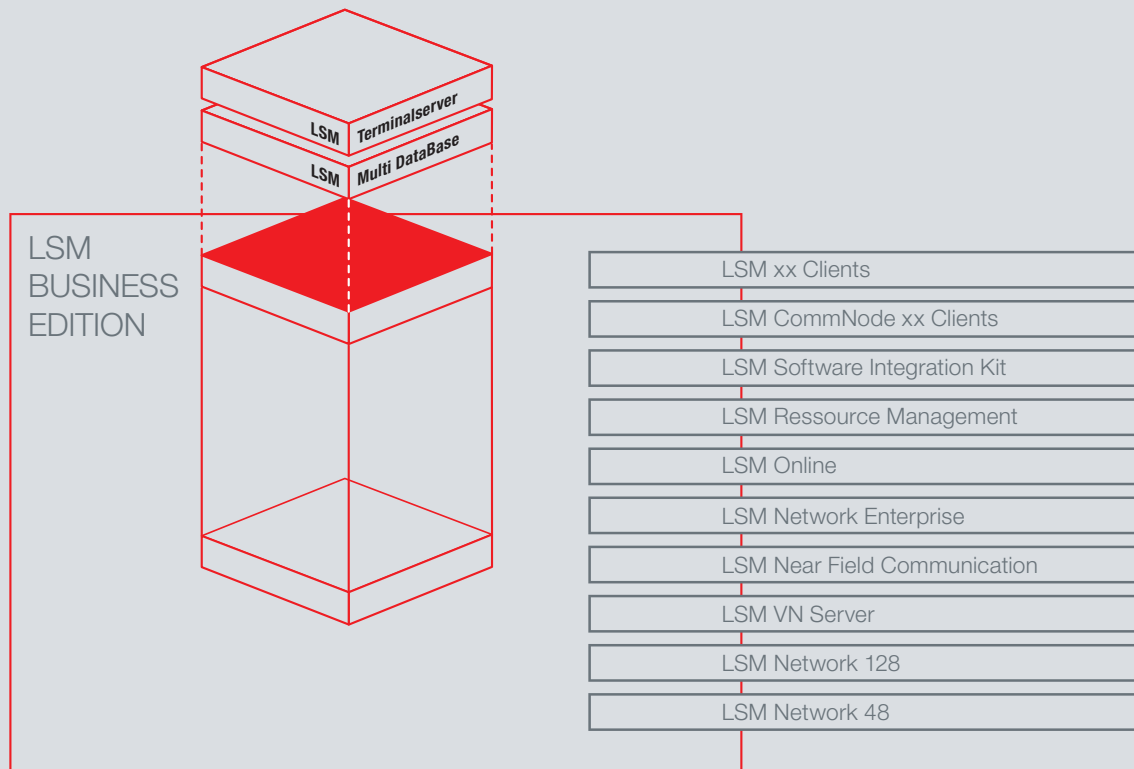

MODULES FOR LSM BUSINESS EDITION.

Same functions as LSM Basic Edition.

Includes modules LSM Monitor, LSM Report and LSM Database Server. An SLA must be entered into. The following extension modules can also be ordered:

- ⚡ LSM NETWORK 48/128:
Network functionality for a maximum of 48 or 128 networked Components
- ⚡ LSM VN SERVER:
Virtual network, automatic distribution of authorisation information in the G2 system via gateways and transponders for easy SimonsVoss system administration
- ⚡ LSM NEAR FIELD COMMUNICATION:
To upgrade to include NFC technology in conjunction with a smart phone
- ⚡ LSM NETWORK ENTERPRISE:
Network functionality for any large number of networked components
- ⚡ LSM ONLINE:
Only in combination with one of the LSM.NW-xx network modules; task management, alert management, event management, access to SimonsVoss Event Agent, text messaging functions, e-mail functions. The LSM Online module is required if you wish to use network functions at all workstations
- ⚡ LSM SOFTWARE INTEGRATION KIT
Software interface to link third-party systems
- ⚡ LSMRESOURCE MANAGEMENT:
Time restriction on authorisations. Prerequisite: LSMONLINE
- ⚡ LSM COMM NODE XX CLIENTS/
LSM COMM NODE ENTERPRISE:
Activation of SimonsVoss hardware components from up to 5/10 computers or from an unlimited number of computers without graphical user interface (GUI) using additional software
- ⚡ LSM 03 CLIENTS:
First database licence extension to include 3 more workstation installations, making a total of 4 workstations
- ⚡ LSM XX CLIENTS:
Database licence extension to include 5/10/25 or 50 more workstations; prerequisite: LSM 03Clients

EXTENSION MODULES

- ⚡ LSM MULTI DATABASE:
Use of a number of different LSM databases
- ⚡ LSM TERMINAL SERVER:
Use of LSM in a terminal server environment

LSM PROFESSIONAL EDITION MODULES

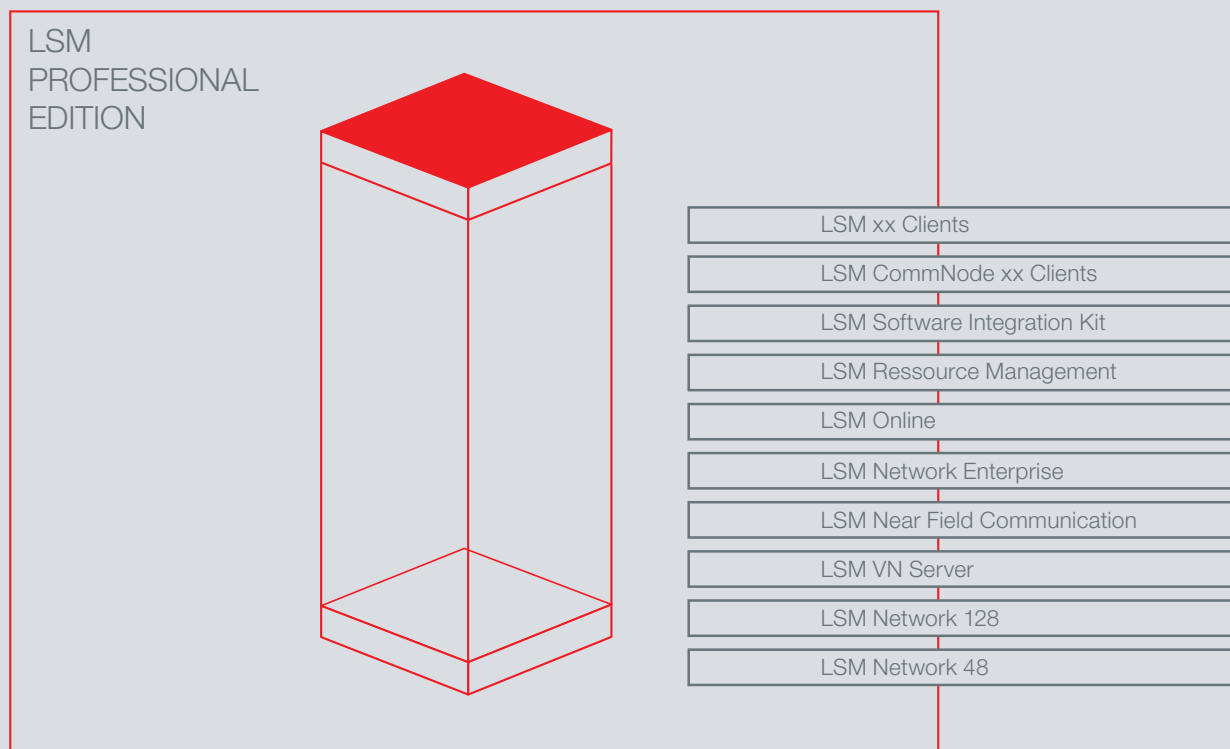

MODULES FOR LSM PROFESSIONAL EDITION.

Same functions as LSM Business Edition.

Includes LSM Terminal Server and LSM Multi Database modules.
An SLA must be entered into. The following extension modules can also be ordered:

- ⚡ LSM NETWORK 48 /128:
Network functionality for a maximum of 48 or 128 networked Components
- ⚡ LSM VN SERVER:
Virtual network, automatic distribution of authorisation information in the G2 system via gateways and transponders for easy SimonsVoss system administration
- ⚡ LSM NEAR FIELD COMMUNICATION:
To upgrade to include NFC technology in conjunction with a smart phone
- ⚡ LSM NETWORK ENTERPRISE:
Network functionality for any large number of networked components
- ⚡ LSM SOFTWARE INTEGRATION KIT
Software interface to link third-party systems
- ⚡ LSM ONLINE:
Only in combination with one of the LSM.NW-xx network modules; task management, alert management, event management, access to SimonsVoss Event Agent, text messaging functions, e-mail functions. The LSM Online module is required if you wish to use network functions at all workstations
- ⚡ LSM RESSOURCE MANAGEMENT:
Time restriction on authorisations. Prerequisite LSM OONLINE
- ⚡ LSM COMM NODE XX CLIENTS/
LSM COMM NODE ENTERPRISE:
Activation of SimonsVoss hardware components from up to 5/10 computers or from an unlimited number of computers without graphical user interface (GUI) using additional software
- ⚡ LSM 03 CLIENTS:
First database licence extension to include 3 more workstation installations, making a total of 4 workstations
- ⚡ LSM XX CLIENTS:
Database licence to include 5/10/25 or 50 more workstations; prerequisite: LSM 03 Clients

LSM SOFTWARE EDITIONS AND MODULES

PRODUCT VERSIONS

SOFTWARE EDITIONS

| | |
|--|----------------------|
| LSM Starter Edition software for installation on a PC/laptop (please note system requirements) | LSM.STARTER |
| Software LSM Basic Edition for installation on a PC/laptop (please note system requirements) | LSM.BASIC |
| Software LSM Business Edition for installation on a PC/laptop (please note system requirements) | LSM.BUSINESS |
| Software LSM Professional Edition for installation on a PC/laptop (please note system requirements) | LSM. PROFESSIONAL |
| Software LSM Mobile Edition for installation on a portable terminal device (please note system requirements) | LSM.MOBILE |

SOFTWARE MODULES FOR LSM BASIC

| | |
|--|-------------|
| LSM Monitor module Module to log system changes in the software (audit compliance) | LSM.MONITOR |
| LSM Report module Module to add extensive reporting | LSM.REPORT |
| LSM Network 48 module Module to extend network functionality to cover a maximum of 48 networked components | LSM.NW-48 |
| LSM Network 128 module Module to extend network functionality to cover a maximum of 128 networked components | LSM.NW-128 |
| LSM VN Server module Module to add G2 'virtual networking' functions; automatic distribution of authorisation information to the G2 system via gateways and transponders for easy SimonsVoss system administration. Hardware and software components must support G2 | LSM.VN |
| LSM Near Field Communication module To upgrade to include NFC technology in conjunction with a smart phone | LSM.NFC |
| LSM Database Server module, GUI installation on one workstation (PC/laptop), client-server operation; includes Comm Node Server, multi-user capability, multi-client capability, user roles, functions: transponder groups and areas to map building and organisational structures, use of several locking systems, data exchange with portable terminal devices (PDAs/netbooks); prerequisite are LSM.MONITOR and LSM.REPORT modules; installation by certified SimonsVoss dealer only; a service level agreement (SLA) must be entered into | LSM.DB |
| LSM Database Server, same functions as LSM.DB; to install GUI on up to four workstations | LSM.DB-005 |
| LSM Database Server, same functions as LSM.DB to install GUI on up to nine workstations | LSM.DB-010 |
| LSM Database Server, same functions as LSM.DB to install GUI on up to xx workstations | LSM.DB-0xx |

LSM SOFTWARE SYSTEM REQUIREMENTS

GENERAL INFORMATION

- ⌘ Local administrator rights for installation
- ⌘ Communication: TCP/IP (Net Bios active), LAN
(Recommended: 100 MBit)
- ⌘ Windows domain
- ⌘ Name resolution
- ⌘ .NET Framework 2.0 min., 3.5 recommended
- ⌘ MS ActiveSync 4.2 in combination with a pocket PC
- ⌘ RS-232 and/or USB port

CLIENT

(LSM STARTER, LSM BASIC, LSM BUSINESS, LSM PROFESSIONAL)

Minimum hardware requirements

- ⌘ Monitor min. 19" (48 cm) (or larger for matrix view display)
- ⌘ Screen resolution at least 1024x768; recommended:
1280x1024
- ⌘ Processor: at least 2.66 GHz (or faster)
- ⌘ At least 2 GB RAM (or more)
- ⌘ Hard disk size: 500 MB (about 1 GB during installation);
database depends on the processed data (about 30 MB)
- ⌘ MS Windows XP Prof. SP3
- ⌘ MS Windows Vista (Business, Enterprise, Ultimate),
32 or 64 bit
- ⌘ MS Windows 7 (Professional, Enterprise, Ultimate),
32 or 64 bit
- ⌘ MS Windows 8 (Professional, Enterprise),
32 or 64 bit

SERVER

(DATABASE SERVER FOR LSM BUSINESS EDITION OR HIGHER)

Minimum hardware requirements

- ⌘ Processor: at least 2.66 GHz (or faster)
- ⌘ At least 2 GB RAM (or more)
- ⌘ Hard disk application capacity approx. 300 MB (approx. 500 MB
during installation); database depends on the volume of data to be
processed (approx. 30 MB)
- ⌘ MS Windows Server 2003
- ⌘ MS Windows Server 2008
- ⌘ MS Windows Server 2008 R2
- ⌘ .NET Framework at least 3.5 when using the Comm Node Server
- ⌘ Server-based application: needs to be enabled for the ADS server
for the database directory

SUPPORT



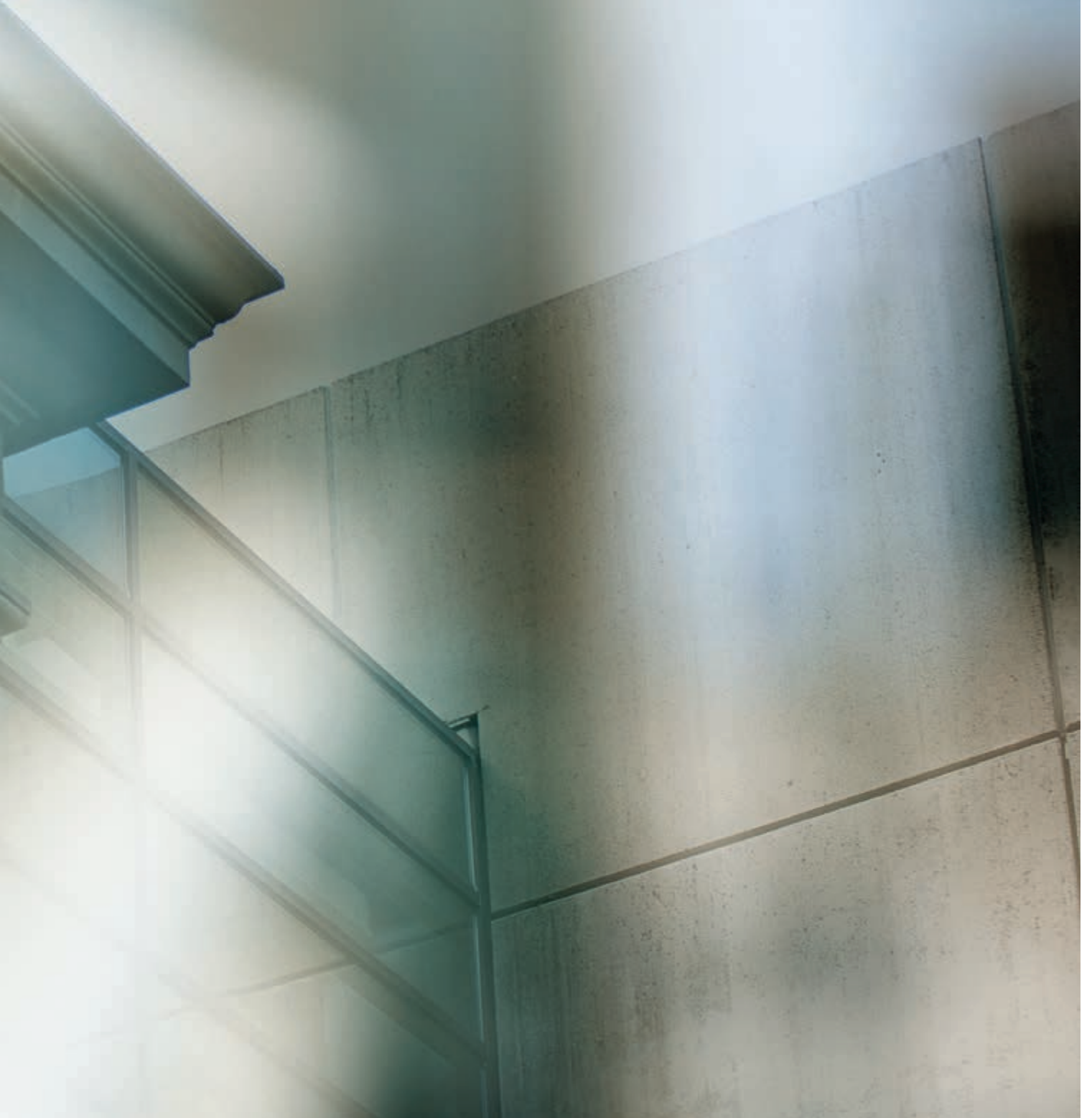

SERVICES AND TRAINING

SERVICES

| | |
|---|----------|
| On-site project work | PROJEKT |
| Initial operation of components on site | INSTALL |
| Training on-site in building | SCHULUNG |
| Services as per service report | DIENST |

TRAINING IN MUNICH

| | |
|-------------------------------------|---------------|
| Basic (1 day) | BASIS.MUC |
| Technical I/workshop (2 days) | TECHNIK1.MUC |
| Technical for professionals (1 day) | TECHNIK2.MUC |
| Network I (1 day) | NETZWERK1.MUC |
| Network for professionals (1 day) | NETZWERK2.MUC |

MOCK-UP

| | |
|---|---------------------|
| Demo model of G2 digital locking cylinder with standard fittings | MOCKUP.G2 |
| Demo model of digital locking cylinder for smart cards with standard fittings | MOCKUP.Z4.MH |
| Demo model of G2 Smart Handle 3062 | MOCKUP.SH.G2 |
| Demo model of G2 SC Smart Handle 3062 | MOCKUP.SH.MH. G2 |
| Demo model of Network Inside | MOCKUP.LNI |
| Robust aluminium case for mock-ups | MC |

SALES SUPPORT

PRODUCT PEDESTAL

Large presentation pedestal for System 3060, height: 2 m width/depth: 60 cm, on rotating base.
 With integrated doors that are equipped with a Digital Locking Cylinder 3061 and a digital Smart Handle and which can be opened using a PIN code keypad or a smart card.
 Four presentation surfaces (transponder, cylinder, programming, networking) with product samples;
 includes wooden transport crate

PRODUKTSTELE

SAMPLE CASE

Sample case with samples (sturdy aluminium case: 440 x 330 x 80 mm)
 to present System 3060; contents:
 1 digital locking cylinder (Z4.30-30.FD.ZK.G2)
 1 digital half cylinder (Z4.35-10.HZ.MR.ZK.G2)
 1 network thumb-turn cover to directly network locking cylinder (WNM.LN.I)
 2 transponders (TRA.G2, TRA.G2.ROT.RFID.DESFIRE)
 1 Compact Reader (TRA.CR.MIFARE)
 1 PIN code keypad (TRA.PINCODE)
 1 Digital Smart Relay ZK (SREL2.ZK.MH.G2.W)
 1 smart card reader, internal (SC.M.I.G2)
 1 Lock Node to be integrated into the Smart Relay 2 housing (WNM.LN.I.SREL2.G2)
 1 SmartCD (SMARTCD.G2)

KOFFER.SET.G2

Case without samples
 (aluminium case 440 x 330 x 80 mm)

KOFFER.SET.U

MANUALS

Planning handbook

HB.PL

PRODUCT OVERVIEW

| | | | |
|--|-----------|------------------------------------|-----------|
| ACTIVE TECHNOLOGY | 8 | | |
| IDENTIFICATION MEDIA AND THEIR PROGRAMMING | 11 | BLOCK LOCK 3066 | 71 |
| Transponder 3064 | 12 | Mode of operation | 72 |
| Biometric Reader Q3008 | 15 | VDS Block Lock 3066 | 73 |
| PIN Code Keypad 3068 / PIN Code Terminal 3068 | 16 | | |
| Smart Clip 3069 | 17 | OTHER PRODUCTS | 75 |
| Programming | 18 | Digital switchgear cabinet handles | 76 |
| | | Digital lever locks | 76 |
| | | Digital padlocks | 77 |
| DIGITAL LOCKING CYLINDERS 3061 | 21 | | |
| Digital Euro Profile Double Thumb-turn Cylinder 3061 – FD | 22 | | |
| Digital Euro Profile Double Thumb-turn Cylinder 3061 – Anti-Panic | 24 | | |
| Digital Euro Profile Double Thumb-turn Cylinder 3061 – Comfort | 26 | | |
| Digital Euro Profile Double Thumb-turn Cylinder 3061 – Door Monitoring | 28 | | |
| Digital Euro Profile Half Cylinder 3061 | 32 | | |
| Digital Euro Profile Half Cylinder 3061 – Door Monitoring | 34 | | |
| Digital Scandinavian Oval Cylinder 3061 (with accessories) | 36 | | |
| Digital Scandinavian Round Cylinder 3061 (with accessories) | 38 | | |
| Digital British Oval Cylinder 3061 | 40 | | |
| Digital British Oval Cylinder 3061 – Comfort | 42 | | |
| Digital Swiss Round Cylinder 3061 – Comfort | 44 | | |
| Digital Swiss Round Half Cylinder 3061 | 46 | | |
| Thumb-turns & accessories | 48 | | |
| Configuration – Digital locking cylinders | 50 | | |
| | | | |
| DIGITAL SMART HANDLES 3062 | 55 | | |
| Order overview | 56 | | |
| Digital Smart Handle 3062 | 57 | | |
| Digital Smart Handle 3062 – Scandinavian Oval | 62 | | |
| | | | |
| DIGITAL SMART RELAY 3063 | 65 | | |
| Digital Smart Relay 3063 | 66 | | |
| Digital Smart Output Module | 68 | | |
| Digital Smart Relay 2 3063 | 69 | | |

PRODUCT OVERVIEW

| | | | |
|--|-----------|---|------------|
| PASSIVE SMART CARD TECHNOLOGY | 78 | | |
| IDENTIFICATION MEDIA AND THEIR PROGRAMMING | 81 | OTHER PRODUCTS | 146 |
| Smart cards / smart tags | 82 | Digital padlocks | 147 |
| Mobile Key | 84 | | |
| Smart Reader 3078 | 86 | MULTI-NETWORKING | 148 |
| Compact Reader 3078 | 87 | Mode of operation | 150 |
| Programming | 88 | WaveNet Radio Network 3065 | 151 |
| | | WaveNet Router – Protective Function | 153 |
| | | WaveNet Radio Network 3065 – Direct Networking | 155 |
| | | WaveNet Radio Network 3065 – Accessories and Lock Node licences | 157 |
| DIGITAL LOCKING CYLINDER 3061 – SC | 91 | | |
| Digital Euro Profile Double Thumb-turn Cylinder 3061 – SC – Comfort | 92 | LSM SOFTWARE | 158 |
| Digital Euro Profile Double Thumb-turn Cylinder 3061 – SC – FD | 94 | LSM software | 160 |
| Digital Euro Profile Double Thumb-turn Cylinder 3061 – SC – Anti-Panic | 96 | LSM editions and modules overviews | 162 |
| Digital Euro Profile Half Cylinder 3061 – SC | 98 | LSM concepts and topologies | 164 |
| Digital Scandinavian Oval Cylinder 3061 – SC | 100 | LSM software editions | 165 |
| Digital Scandinavian Round Cylinder 3061 – SC | 102 | LSM Starter Editions | 166 |
| Digital Swiss Round Double Thumb-turn Cylinder 3061 – SC | 104 | LSM Basic Edition modules | 167 |
| Digital Swiss Round Half Cylinder 3061 – SC | 106 | LSM Business Edition modules | 168 |
| Digital British Oval Double Thumb-turn Cylinder 3061 – SC – Comfort | 108 | LSM Professional Edition modules | 169 |
| Digital British Oval Double Thumb-turn Cylinder 3061 – SC – FD | 110 | LSM software editions and modules | 170 |
| Digital locking cylinder configuration – SC | 112 | LSM system requirements | 171 |
| | | | |
| DIGITAL LOCKING CYLINDER 3061 – HYBRID | 115 | SUPPORT | 172 |
| Digital Euro Profile Double Thumb-turn Cylinder 3061 – Hybrid | 116 | Services and training | 174 |
| Digital British Oval Double Thumb-turn Cylinder 3061 – Hybrid | 118 | Sales support | 175 |
| Digital locking cylinder configuration – Hybrid | 120 | Product overview | 176 |
| | | | |
| Thumb-turns & accessories | 121 | | |
| | | | |
| DIGITAL SMART HANDLES 3062 – SC | 123 | | |
| Order overview | 124 | | |
| Digital Smart Handle 3062 – SC | 125 | | |
| Digital Smart Handle 3062 – Scandinavian Oval – SC | 130 | | |
| Digital Smart Handle 3062 – Hybrid | 134 | | |
| Digital Smart Handle 3062 – Scandinavian Oval – Hybrid | 140 | | |
| | | | |
| DIGITAL SMART RELAY 2 3063 | 143 | | |
| Digital Smart Relay 2 3063 | 144 | | |

SIMONS VOSS WORLDWIDE

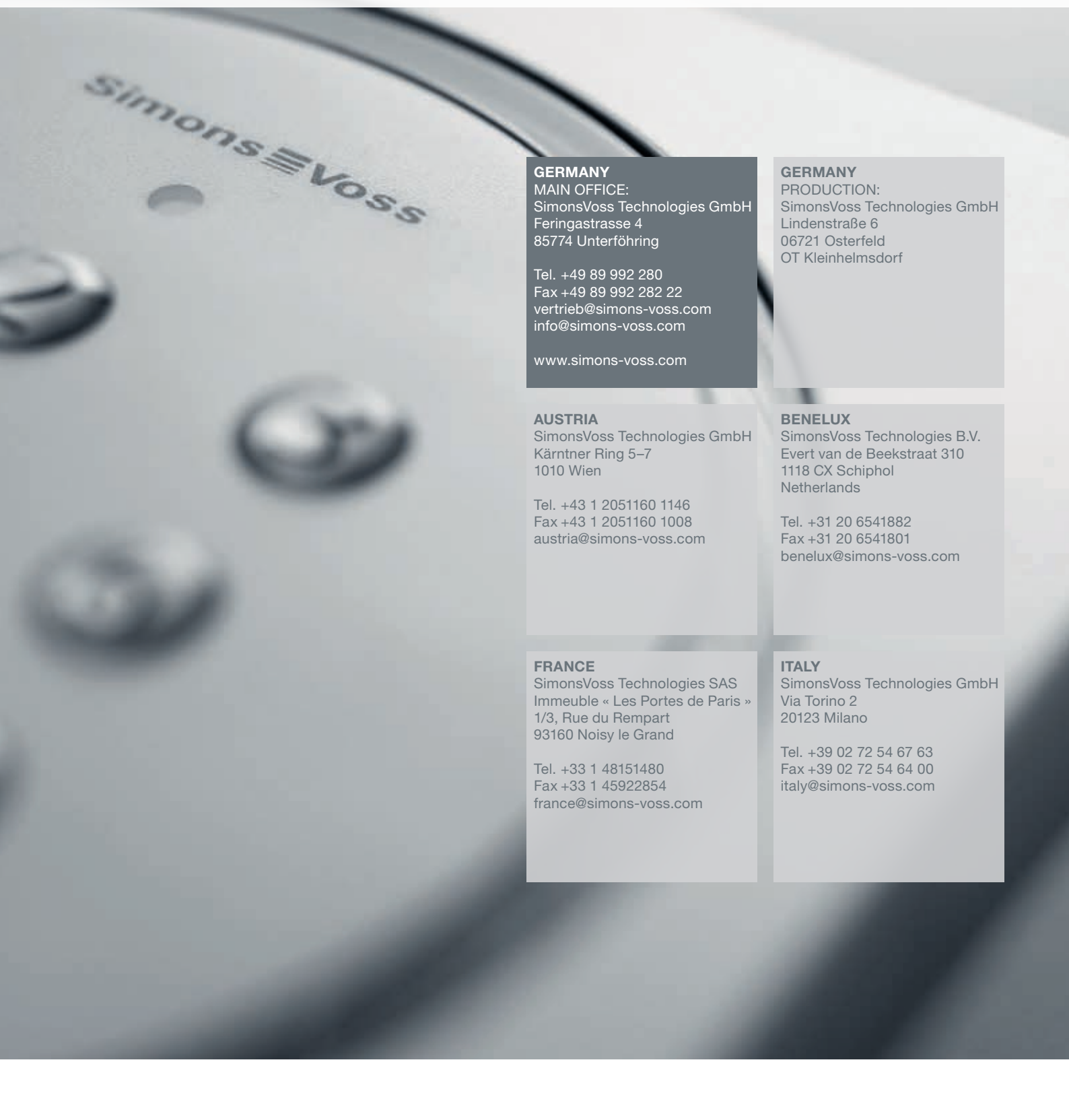

GERMANY

MAIN OFFICE:
SimonsVoss Technologies GmbH
Feringastrasse 4
85774 Unterföhring

Tel. +49 89 992 280
Fax +49 89 992 282 22
vertrieb@simons-voss.com
info@simons-voss.com

www.simons-voss.com

GERMANY

PRODUCTION:
SimonsVoss Technologies GmbH
Lindenstraße 6
06721 Osterfeld
OT Kleinhelmsdorf

AUSTRIA

SimonsVoss Technologies GmbH
Kärntner Ring 5-7
1010 Wien

Tel. +43 1 2051160 1146
Fax +43 1 2051160 1008
austria@simons-voss.com

BENELUX

SimonsVoss Technologies B.V.
Evert van de Beekstraat 310
1118 CX Schiphol
Netherlands

Tel. +31 20 6541882
Fax +31 20 6541801
benelux@simons-voss.com

FRANCE

SimonsVoss Technologies SAS
Immeuble « Les Portes de Paris »
1/3, Rue du Rempart
93160 Noisy le Grand

Tel. +33 1 48151480
Fax +33 1 45922854
france@simons-voss.com

ITALY

SimonsVoss Technologies GmbH
Via Torino 2
20123 Milano

Tel. +39 02 72 54 67 63
Fax +39 02 72 54 64 00
italy@simons-voss.com

NORDIC COUNTRIES

SimonsVoss Technologies AB
Ostermalmstorg 1
Stockholm 114 42
Sweden

Tel. +46 850 25 66 63
Fax +46 850 25 65 00
nordic@simons-voss.com

SWITZERLAND

SimonsVoss Technologies GmbH
Dreikönigstrasse 31a
8002 Zürich

Tel. +41 44 208 -3241
Fax +41 44 208 -35 00
swiss@simons-voss.com

THE UK

SimonsVoss Technologies Ltd.
1200 Century Way
Thorpe Park, Colton
Leeds LS15 8ZA

Tel. +44 113 2515 036
Fax +44 113 2515 360
uk@simons-voss.com

RUSSIA

SimonsVoss Technologies GmbH
RF, 115191,
Moskau, Ul. B.
Tulskaja, 10/2

Tel. +7 495 737 72 08
russia@simons-voss.com

ASIA

SimonsVoss
Security Technologies
(Asia) Pte. Ltd.
178 Paya Lebar Road
#04-10 Paya Lebar 178
Singapore 409030
Republic of Singapore

Tel. +65 6227 7318
Fax +65 6227 7018
asia@simons-voss.com

MIDDLE EAST

SimonsVoss Technologies
(Middle East) FZE
P.O. Box 184220
Dubai UAE

Tel. +971 4 22748 51
Fax +971 4 22748 53
uae@simons-voss.com

© Copyright 2014, SimonsVoss Technologies GmbH,
Unterföhring, Germany.
All rights are reserved. Text, images and diagrams are
protected under copyright law. The contents of this
brochure must not be copied, distributed or modified.
You can find authoritative, detailed technical information
in the system manual. Subject to technical changes.

EN-2014-11

SIMONS VOSS TECHNOLOGIES GMBH
Feringastrasse 4
85774 Unterföhring
Germany
Tel. +49 89 992 280
Fax +49 89 992 282 22
info@simons-voss.com
www.simons-voss.com